

TORRO COMBILINE

PÖTTINGER high output multipurpose loader wagon with rotor





High output with excellent cost effectiveness

To meet the varying demands placed on the loader wagon in combination with individual customer requirements, PÖTTINGER now offers the TORRO models as combined loader/top-fill wagons.

TORRO COMBILINE – loader wagon technology 2 in 1 silage/harvesting combination

Maximum versatility and increased machine utilisation are guaranteed as a result. In combination with its high output, the TORRO COMBILINE offers excellent cost effectiveness, again underlining the significance of the loader wagon as the harvesting process for the future.

Contents

	Page
Frame / Bodywork / Drawbar	4
Driveline / Power train	6
Pick-up / Loading rotor / Chopping system	8
Automatic loading / Unloading	14
Chassis / Tyres	18
Operation	21
Technical data / Equipment	22

All information on technical data, dimensions, weights, output, etc. and the images shown, are approximate and are not binding. The machines shown do not feature country-specific equipment and may include equipment that is not supplied as standard, or is not available in all regions. Your PÖTTINGER dealership would be pleased to provide you with more information.

Impressive construction



Easy hitching

A turning angle of up to 60° is possible even with steered axles, dependent on the tractor and tyres thanks to the narrow design of the drawbar.

All hoses and cables are routed tidily through the hose holder.

High or low drawbar

Choose 2 t, 3 t or 4 t drawbar load, drawbar shock absorber is fitted as standard equipment. Automatic transport and loading position for drawbar available as an option.

Hydraulic controlled steering

This steering system complies with the DIN ISO 26402 standard and guarantees that the wagon follows in tractor's tracks across slopes and in the clamp.

- Compact, fail-safe design.
- Track rod with automatic interlock for single-handed attachment.

Electro-hydraulic controlled steering

A high level of stability when driving at high speeds and the best manoeuvrability in tight corners is ensured by the speed-dependent steering angle adjustment system. In the field, a tighter turning angle ensures greater manoeuvrability and protects the ground. At high driving speeds, less of a turning angle ensures a higher level of safety. Tandem and tridem axles only require a single track rod control.

- Load sensing, air brakes and 26.5" tyres are required.
- Lowest tyre wear.
- Easy hitching.
- Compact design without mechanical components.
- Axles can be locked by pressing a button on the terminal.

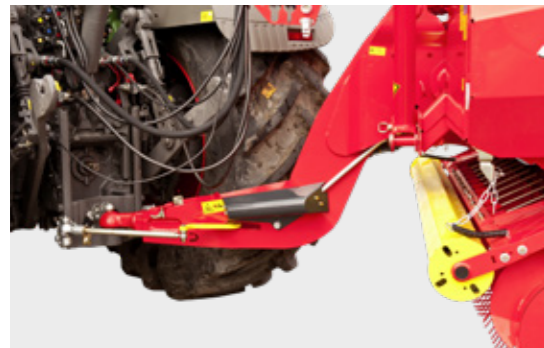

Strong frame

The frame components are constructed using high quality QSTE fine-grained steel. The frame and side pillars are secured using fine thread bolts - no welds. Closely-spaced pillars and high-strength side profiles ensure the highest strength.

- Clear inside width of 2.30 m.
- Smooth wall panels with a special coating ensure the wagon is completely empty of forage after unloading.
- Tailgate opening angle can be adjusted as required from the tractor seat.
- Enter the wagon's loading chamber using a convenient access ladder.
- Floodlights mounted on the front panel provide excellent illumination of the loading chamber in the dark.



Bodywork options

- Roof ropes with rear tarpaulin for retaining crop material with a low density.
- Roof rope release system in conjunction with the hydraulic folding loading flap.
- LED floodlights on front panel and mudguards.
- LED package (loading chamber, tailgate, pick-up, knife bank with POWER CONTROL).
- Video system with monitor and one or two cameras.
- Flashing beacon.



Power transfer up to 300 hp



10% more output

The driveline is designed for high outputs. TORRO loader wagons are designed for tractors of up to 300 hp.

These new models are driven by a PTO shaft with a wide-angled joint and a cam-type clutch to protect the driveline. The large-dimensioned grease filled rotor side drive gearbox is completely maintenance-free.

- The main bearing is located on the rotor frame between the rotor and gearbox to protect the bearing and gearbox.
- The driveline is protected to an impressive torque of 2300 Nm, corresponding to a peak power output of 221 kW / 300 hp.
- This represents an increase in performance of 10% over the previous model.

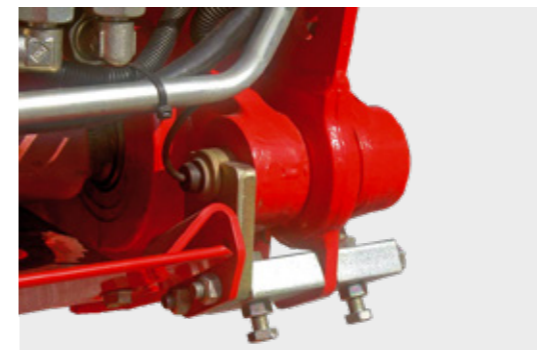

ISOBUS control

A load cell on the rotor gearbox measures the drive torque and can be precisely adjusted to the type of crop. During loading, the torque sensor on the gearbox together with sensors in the front panel and the automatic loading flap control the scraper floor to deliver complete forage protection without leaving the tractor seat.

Load sensing

All PÖTTINGER loader wagons are load-sensing compatible. The required oil flowrate is precisely measured and adjusted to demand. This prevents the oil from heating up and reduces the power requirement by up to 20 hp (15 kW).

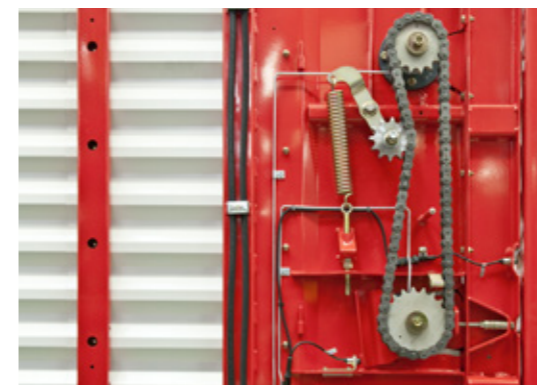

New beater rotor driveline

The driveline to the beater rotors is concealed within the frame. The high-strength drive shaft is protected by a cam-type clutch set at 1700 Nm. New: Double the unloading performance.

High performance pick-up

with 6 rows of tines

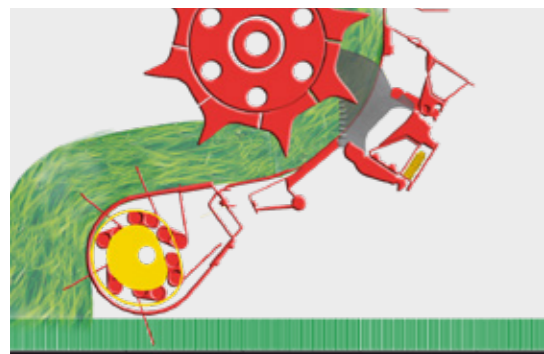
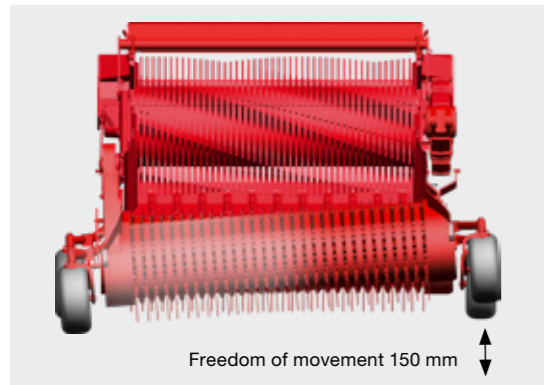

Floating pick-up system

Maximum intake

The PÖTTINGER floating pick-up, with six rows of tines, delivers impressive performance. A reliable and high intake pick-up is still achieved at high forward speeds and in difficult harvest conditions.

Best ground tracking

Two jointed support arms ensure the pick-up has complete freedom of movement. A spring alleviates the pickup weight so less pressure is exerted on the ground. Height-adjustable 16 x 6.5-8 trailed jockey wheels contact the ground on precisely the same line as the tines to ensure perfect ground tracking and cornering.

- Unique travel of 150 mm for perfect ground tracking and exact contouring.
- Automatic pick-up reel switch off on TORRO D models with beaters.

Perfect forage flow

The PÖTTINGER pick-up guarantees the maximum feed rate.

- A large swath roller with crop transfer rods ensures perfect crop flow and a high loading speed.
- The transfer zone from the pick-up tines to the rotor has been optimised and adapted to high throughput.
- The rotor conveys the forage smoothly through the chopping system and into the load chamber.

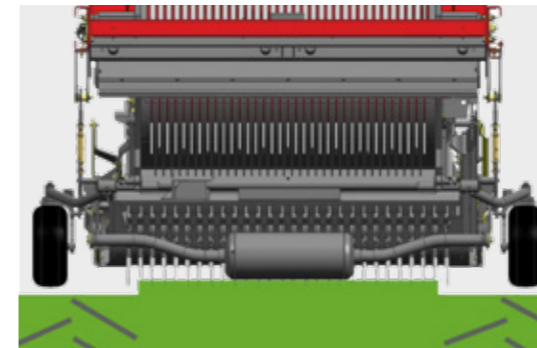

Controlled pick-up for clean forage

The pick-up is controlled from both ends by a steel cam track. The sealed twin-race roller bearings fitted to the cam rollers are designed to withstand high stresses.

- Clean forage is the result thanks to reduced speed and controlled tine movement. The tines are slightly trailed to sweep in a controlled arc and adapt ideally to contours.
- Perfect transfer to the rotor in all conditions with fully active tine length up to withdrawal point.
- The forage is not dragged through, so there is less longitudinal alignment of stalks. The result is a much improved chopping quality.
- The cam track only needs to be greased once per year. The main bearings have a lubrication interval of 80 loads and are easily lubricated without having to remove guards.

Additional tracking roller behind pick-up

This newly developed additional tracking roller is located behind the middle of the pick-up on PÖTTINGER loader wagons. Being located in the centre prevents it from sinking into tractor wheel marks and as a result guarantees perfect ground tracking.

The parallel linkage makes all the difference

The parallel linkage ensures significantly improved contour tracking for clean forage, even in difficult conditions. 100% freedom of movement of the pick-up is ensured. The front jockey wheels are adjusted independently.

- The additional tracking roller is raised with the pick-up.
- Full ground clearance is still ensured.

POWERMATIC PLUS

Loading and chopping



POWERMATIC PLUS loading rotor - smooth running and fuel saving

POWERMATIC PLUS is the heart of TORRO series loader wagons. Rugged and powerful, this rotor delivers high throughput during chopping and compression. POWERMATIC PLUS represents smooth, efficient collection of the crop and perfect transfer from the pick-up.

- The loading rotor has eight rows of tines arranged in a spiral and a diameter of 800 mm.
- The loading rotor is mounted on self-aligning ball bearings at both ends.
- The bearing is located on the rotor frame between the rotor and gearbox to protect the bearings and gearbox.

Optimised tine geometry

Wide surfaces on the tine points ensure maximum performance even with wet and short forage. The optimised tine shape and large scraper surface ensure the best possible compression in the loading chamber. The conveyor tines are made of hardened fine-grain Durostat 500 and are 10 mm thick. The tine rings are hooked into the central drum and welded around the circumference for exact positioning.

The scrapers have a 20 mm wide rear face and are individually mounted and bolted. They ensure highest possible compression, depending on how the automatic loading system is set.

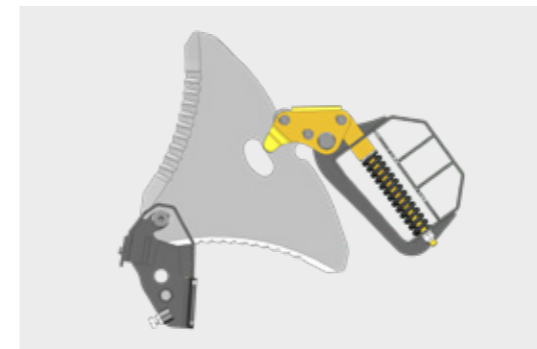

45 knives - 34 mm knife spacing

Consistent and uniform chopping ensures ideally structured ruminant stimulating forage. An optimum distance between the knives and tines ensures smooth operation and protects the knives from foreign objects.

TWIN BLADE reversible knives optional

- The newly-developed and patented geometry of the reversible TWIN BLADE knife doubles the service life.
- A consistent perfect chop is ensured while replacement knives are always on-board.



EASY MOVE

This unique swing-out knife bank makes light work of changing the knives.

Press a button on the side of the wagon to move the knife bank support arms downwards and release the chopping system. Now you can simply pull the knife bank out alongside the wagon - a unique system.

Central knife release system as standard

Press the central knife release button to disengage the knives so they can easily be removed without the need for tools.

The knife retention springs and tilting levers on the proven individual knife protection system are recessed safely out of the way. This greatly reduces the contamination of the knife holders. The chopping system can be pivoted out directly from the tractor seat to clear any blockages.

Unique chopping unit

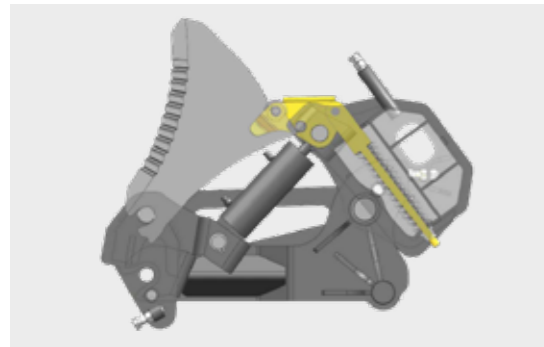

Highest quality knives

The knives are produced from hardened tool steel and their pressed serrated edge ensures a precise chop. The extra thick rear edge of the knife guarantees an extended service life.

Ensuring knife protection

PÖTTINGER protects the heart of the loader wagon with a patented individual knife protection system. Foreign bodies are a danger to the rotor and chopping system plus downtime can be expensive.

The triggering force is adapted to the high throughput and capacity. The knives are held securely in the correct position to make sure that a consistent chop length is produced.

Patented trigger mechanism

- Larger foreign objects only move the knife briefly in the direction of crop flow.
- The trigger roller is lifted out of its holder at the back of the knife.
- The resistance of the knife is suddenly reduced so that the knife can allow the foreign object to pass through virtually unobstructed. The sharpness of the knife is retained.
- The knife is then automatically brought back into the working position.

Any stones in the forage are not pulverised like they are in harvesters. The cattle leave them in the trough so that injuries to the digestive system are avoided.

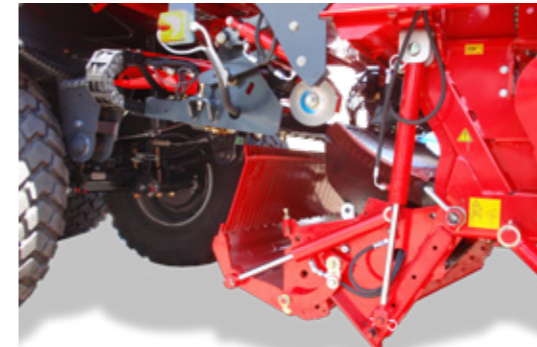
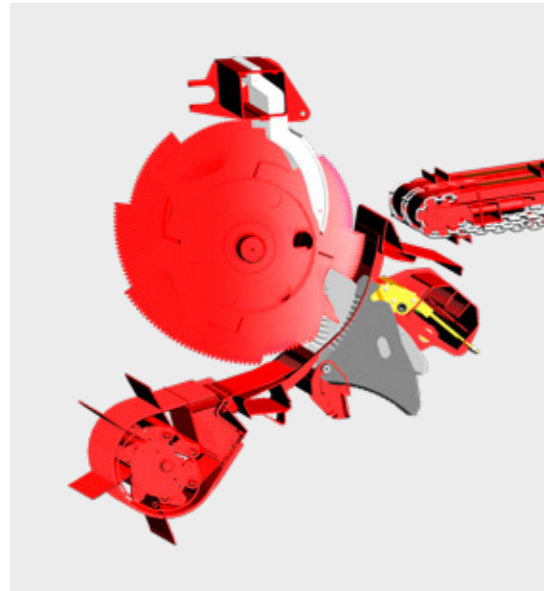

AUTOCUT knife sharpening system

A precise and consistent chop is the basis for the best silage quality. AUTOCUT delivers consistent chopping quality throughout a whole working day.

The AUTOCUT knife sharpening system enables convenient knife sharpening directly on the loader wagon. Depending on the wear of the knives, simply select the sharpening cycle using the control terminal. This considerably reduces maintenance expenses and at the same time guarantees long-lasting optimal cutting quality with lower energy consumption and increased output.

Consistent chop length

The crop is chopped in precisely the same way again and again, and is not squashed.

15% less power needed

- Saves on diesel consumption by approx. 5 litres/hour
- Increase in output
- Even greater cost savings

Much lower maintenance requirement

- Fully automatic sharpening of the complete set of knives in around 4 minutes per cycle
- Time spent on maintenance is reduced by about 45 minutes per day

How you benefit:

- Cleaning comb cleans the knives when they fold out
- Optimised grinding wheel sharpens even contaminated knives
- Sharpening angle is adjustable
- Sharpening intensity can be adjusted if required using pressure regulator
- Fully automatic sharpening of the complete knife set
- Sharpening cycle takes around 4 minutes
- Knives are always kept sharp to ensure best chopping quality
- Significant reduction of maintenance expenses

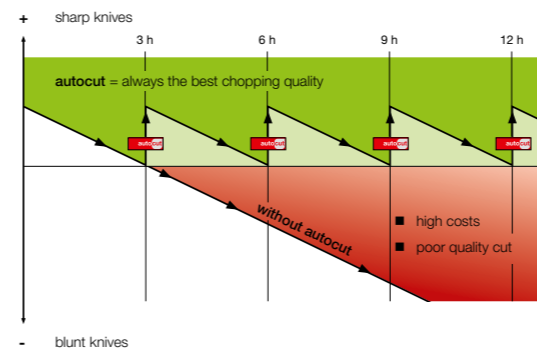

COMBILINE

Multi-purpose



Engineered bodywork

The steel profile panels are fully enclosed, right to the top. The profiled plates have a special coating to guarantee a long service life. The large surface area of the forage compression flap ensures the best compression of the crop and maximum use of the loading chamber. A halogen floodlight in the load chamber is standard.



Automatic loading system as standard

The automatic loading system guarantees that the wagon is filled right up to achieve maximum transport capacity. The forage is already carefully compressed in the transfer throat to make full use of the loading chamber.

Sensors mounted in front panel and upper panel section

A sensor at the lower end of the front panel measures the loading pressure for damp, heavy grass and switches the scraper floor on and off accordingly.

This prevents the forage from being mashed due to excessive load on the loading rotor.

The second sensor in the forage compression flap measures the compression inside the loading chamber. The forage is compressed uniformly and the loading chamber filled to the optimum capacity.

Loading torque measurement optional

The load sensors on the rotor gearbox detects the drive torque. Using the POWER CONTROL operator terminal, the load sensors can control the scraper floor to deliver complete forage protection without leaving the tractor seat.



One front flap - two functions

The forage compression flap is equipped as standard with a hydraulic cylinder which can be controlled from the tractor cab to enable a rapid change between pick-up loading and top-fill loading.

1. Loader wagon mode

In loader wagon mode, the forage compression flap is folded upwards to allow the flow of the crop into the wagon, which is then regulated by the automatic loading system. Compression is adjustable so it can be set to ideally match the power of the tractor.

2. Harvest transport mode

To make full use of the loading chamber, the forage compression flap is lowered inwards.



Folding rotor duct cover

The optional duct cover prevents crop from falling into the rotor duct while the wagon is being used for transport. On PÖTTINGER wagons the duct cover simply folds away without any modifications required.



Tapered mudguards

All TORRO COMBILINE wagons are fitted with tapered mudguards and closed frame beams. Nothing is left lying on the mudguards and as a result no crop falls onto the road during transport.

Unloading at the press of a button



Automatic unloading

A press of a button on the control terminal is all that is needed and the full cross section of the tailgate opens to unload TORRO L models in a few minutes. The automatic unloading system makes life easier for the driver and protects the machine.

Beaters unload according to demand on the TORRO D

A uniformly distributed blanket of forage is essential for perfect compaction. Two beater rotors guarantee perfect distribution. The aggressive tines deliver an impressive performance even with highly compressed forage. Bars on the rotors ensure maize material can be unloaded effectively. A pressure sensor in the beater rotor bearings controls the scraper floor automatically.

Multifunction tailgate

The tailgate opening angle can be set to different positions from the tractor seat to minimise the effects of crosswinds.

- New: Beater driveline protected to 1700 Nm.
- Automatic chain tensioner.
- Easily access central greasing point.
- Third beater rotor available as an option.
- Fine metering optional (only with roof ropes and rear tarpaulin)

Cross conveyor belt

The optional cross conveyor belt is 890 mm wide and is powered hydraulically.

- Runs to left and right.
- Tailgate locking system.
- Remote control using optional POWER CONTROL Wireless.

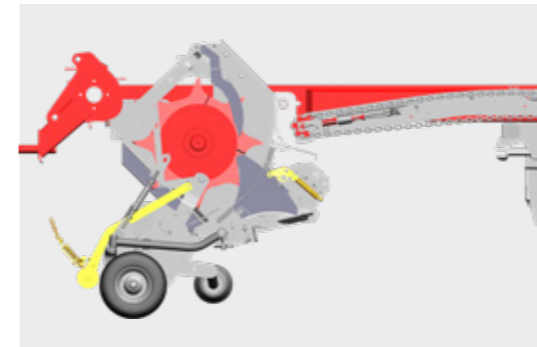

Lowered scraper floor

The scraper floor has been lowered by 150 mm at the front end. The forage is conveyed upwards to the rear for uniform and smooth discharge. Hassle-free unloading with a low power requirement and four powerful drive chains ensure rapid unloading.

- A two-speed motor is standard for unloading speed of up to 18 metres per minute.
- The scraper floor transmission is located on the centreline of the wagon.

Longevity of scraper floor

The PÖTTINGER scraper floor guarantees long term reliability. The load chamber floor is constructed of pressure treated, durable wood. The tongue and groove boards are bolted to the frame. The hardened bars are offset and easily accessible and the the greasing points for the scraper floor shafts are located at the side of the wagon.

Load sensing

All PÖTTINGER loader wagons are load-sensing compatible. The required oil flowrate is precisely measured and adjusted to demand. This prevents the oil from heating up and reduces the power requirement by up to 20 hp (15 kW).

Chassis

Axles for enhanced safety

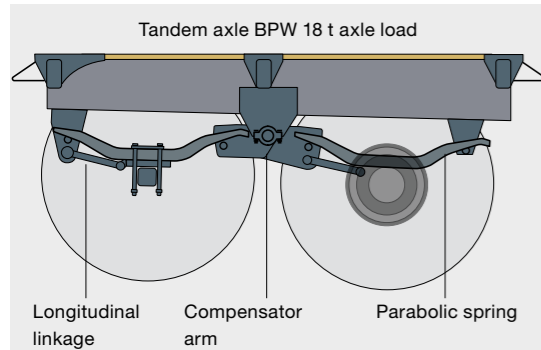

Parabolic leaf spring chassis

The compensator arm ensures dynamic equalisation during braking so the same load acts on each wheel. At the same time you are guaranteed perfect suspension characteristics in the clamp and smooth running in the field and on the road.

- Large spring spacing at front (1100 mm) and rear (856 mm).
- High strength longitudinal linkages apply the braking and steering force.
- Trailed steered axle protects the sward even with heavy loads (standard).
- Hydraulic controlled steering and EBS brakes available as option.
- Electro-hydraulic controlled steering optional.

Parabolic leaf spring chassis for 22.5" / 26.5" tyres with anti roll bar up to 22 t total weight

The advantage of the reinforced parabolic leaf springs with additional anti roll bar is improved driving performance on steep ground and when cornering. 20% higher driving stability.

Hydro-pneumatic chassis with 26.5" / 30.5" tyres up to an overall weight of 24/31.

The hydro-pneumatic chassis offer a wider wheel spacing of 1085 mm for safe driving characteristics in all situations. The large axle compensation of up to 270 mm is designed to handle challenging field entrances and poor track conditions. Highest level of driving comfort in traffic and off-road. Optimum braking power thanks to equal axle load distribution.

Optimum dual-circuit air brakes with electronic braking system EBS - ABS and RSP

While steering or manoeuvring at high speed with a full load or high centre of gravity, there is an increased risk of tipping over. This system detects critical situations by monitoring the lateral acceleration, load weight and driving speed. Automatic braking of individual wheels reduces the speed as well as the lateral acceleration. Driving stability is restored automatically.

Driver assist system

In automatic mode the system locks the axles and stays on course. This is active above a defined speed that can be set between 0 and 25kph, when driving in reverse and when driving at an inclination in the clamp or on steep ground.

TORRO COMBILINE	5510 L / D COMBILINE	6010 L / D COMBILINE	6510 L / D COMBILINE	7010 L / D COMBILINE	8010 L / D COMBILINE
High drawbar 2 t drawbar load	■	■	■	□	□
Low drawbar 2 t drawbar load	□	□	□	□	□
Low drawbar 3 t drawbar load	□	□	□	■	■
Low drawbar 4 t drawbar load	□	□	□	□	□
Automatic transport and loading position for parallel lift drawbar	□	□	□	□	□
Low drawbar with K80 ball hitch	□	□	□	□	□
Chassis with parabolic leaf springs, 18 t axle load	■	■	■	■	■
Chassis with parabolic leaf springs and anti roll bar, 18 t axle load	-	□	□	□	□
Chassis with parabolic leaf springs and hydro-pneumatic suspension, 20 t axle load	-	-	□	□	□
Tridem chassis with hydro-pneumatic suspension, 27 t axle load	-	-	-	□	□
Hydraulic controlled steering with K50 ball hitch	□	□	□	□	□
Electro-hydraulic controlled steering with K50 ball hitch	-	-	□	□	□
Pneumatic brakes	■	■	■	■	■
Air brakes with EBS, ABS and RSP	□	□	□	□	□
Hydraulic brakes	□	□	□	□	□
Emergency brake valve for hydraulic brakes	□	□	□	□	□
Tyres 710/45 R 22.5"	■	■	■	■	■
Tyres 710/45 R 22.5"	□	□	□	-	-
Tyres 710/50 R 26.5"	-	□	□	□	□
Tyres 750/45 R 26.5"	-	□	□	□	□
Tyres 800/45 R 26.5"	-	□	□	□	□
Tyres 710/50 R 30.5"	-	-	-	□	□
Tyres 800/45 R 30.5"	-	-	-	□	□
Weighing system (ISOBUS)	-	-	□	□	□
Permissible total weight 20 t	■	■	■	-	-
Permissible total weight 21 t	□	□	□	■	■
Permissible total weight up to 22 t	□	□	□	□	□
Permissible total weight up to 24 t	-	-	□	□	□
Permissible total weight up to 31 t	-	-	-	□	□

■ = Standard, □ = Optional

Control terminals

Exceptional operating convenience



Convenient operation without ISOBUS

The CONTROL terminals made by PÖTTINGER make your day in the field easier. Intuitive machine operation is ensured by the clearly labelled keys and the ergonomic design. This enables stress-free work, even on long working days. The backlit keys and adjustable brightness display ensure safe operation even at night.

POWER CONTROL (1)

With the POWER CONTROL terminal you can operate all ISOBUS-compatible PÖTTINGER machines. The functions are performed directly at the push of a button without pre-selection or an additional spool valve. The most important keys are labelled directly with the machine-specific functions - which helps drivers regardless of whether they have used the machine before or not. The function keys F1 to F4 can be used to operate additional equipment on your machine. The colour display provides at-a-glance information on functions and the operating status of the machine.



ISOBUS terminals

The ISOBUS terminals EXPERT 75 and CCI 1200 enable professional operation of all ISOBUS-compatible machines made by PÖTTINGER as well as other manufacturers.

EXPERT 75 (2)

The compact 5.6" EXPERT 75 ISOBUS terminal can be operated both directly via the touchscreen and using keys or a scroll wheel. Safe one-hand operation is supported by the grip bar. The ambient light sensor and the illumination of the function keys ensure convenient handling even at night.



CCI 1200 (3)

The new 12" CCI 1200 ISOBUS terminal offers the professional farmer a comprehensive function package. The terminal is operated like a tablet using a touchscreen. Navigation is kept simple so you find what you need with just a few taps. The integrated ambient light sensor automatically adjusts the brightness of the display.

Technical data / Equipment options



Technical data TORRO	5510 L / D COMBILINE	6010 L / D COMBILINE	6510 L / D COMBILINE	7010 L / D COMBILINE	8010 L / D COMBILINE
Capacity	55 m ³	60 m ³	65 m ³	70 m ³	80 m ³
DIN volume	28 / 27 m ³	31.5 / 30.5 m ³	35 / 34 m ³	40 / 38.5 m ³	43 / 42 m ³
Loading volumes with roof ropes 22.5"	29.5 / 28.5 m ³	33 / 32 m ³	36.5 / 35.5 m ³	41 / 39.5 m ³	44.5 / 43 m ³
Volume DIN / 26.5" tyres	–	32 / 31 m ³	35.5 / 34.5 m ³	40 / 38.5 m ³	43 / 42 m ³
Pick-up width	2.0 m (6.6 ft.)	2.0 m (6.6 ft.)	2.0 m (6.6 ft.)	2.0 m (6.6 ft.)	2.0 m (6.6 ft.)
Knives	45	45	45	45	45
Knife spacing	34 mm	34 mm	34 mm	34 mm	34 mm
Loading area length	5.65 / 5.42 m	6.33 / 6.10 m	7.04 / 6.79 m	7.72 / 7.47 m	8.40 / 8.15 m
Loading area width	2.30 m	2.30 m	2.30 m	2.30 m	2.30 m
Length	8.44 / 8.92 m	9.12 / 9.60 m	9.80 / 10.28 m	10.48 / 10.96 m	11.16 / 11.64 m
Width	2.55 m	2.55 m	2.55 m	2.55 m	2.55 m
Height 22.5"	3.65 m	3.65 m	3.65 m	3.73 m	3.73 m
Height 26.5"	–	3.78 m	3.78 m	3.86 m	3.86 m
Height 30.5"	–	–	–	4.00 m	4.00 m
Platform height 22.5"	1.46 m	1.46 m	1.46 m	1.46 m	1.46 m
Platform height 26.5"	–	1.64 m	1.64 m	1.64 m	1.64 m
Platform height 30.5"	–	–	–	1.78 m	1.78 m
Standard weight	7950 / 8450 kg	8300 / 8800 kg	8650 / 9150 kg	8950 / 9450 kg	9150 / 9650 kg
Permissible total weight	20 t	20 t	20 t	21 t	21 t
Permissible total weight maximum	22 t	22 t	24 t	31 t	31 t

More equipment options

PTO shaft 1 3/4" 20 splines
 PTO shaft 1 3/4" 6 splines
 PTO shaft 1 3/8" 21 splines
 PTO shaft 8x32x38 8-spline
 Hydraulic pick-up weight alleviation
 Rear switch for scraper floor
 Load sensing

Roof ropes with rear tarpaulin
 LED floodlights on front panel and mudguards
 LED package (loading chamber, tailgate, pick-up, knife bank with POWER CONTROL).
 Video system with monitor and one or two cameras
 Flashing beacon
 Demarcation lights



**POWER CONTROL
Wireless**



**EXPERT 75 / CCI 1200
ISOBUS**

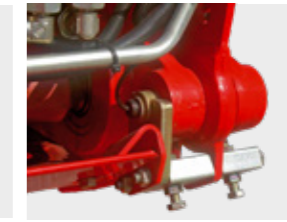

Loading torque sensing



**Additional tracking roller for
pick-up**

TORRO 5510 L / D	<input type="checkbox"/>	<input type="checkbox"/>	<input type="checkbox"/>	<input type="checkbox"/>
TORRO 6010 L / D	<input type="checkbox"/>	<input type="checkbox"/>	<input type="checkbox"/>	<input type="checkbox"/>
TORRO 6510 L / D	<input type="checkbox"/>	<input type="checkbox"/>	<input type="checkbox"/>	<input type="checkbox"/>
TORRO 7010 L / D	<input type="checkbox"/>	<input type="checkbox"/>	<input type="checkbox"/>	<input type="checkbox"/>
TORRO 8010 L / D	<input type="checkbox"/>	<input type="checkbox"/>	<input type="checkbox"/>	<input type="checkbox"/>



**TWIN BLADE
reversible knives**



**AUTOCUT
on-board knife sharpening**



**Loading duct cover for
transport mode**



3rd beater rotor

TORRO 5510 L / D	<input type="checkbox"/>	–	<input type="checkbox"/>	<input type="checkbox"/> D
TORRO 6010 L / D	<input type="checkbox"/>	<input type="checkbox"/>	<input type="checkbox"/>	<input type="checkbox"/> D
TORRO 6510 L / D	<input type="checkbox"/>	<input type="checkbox"/>	<input type="checkbox"/>	<input type="checkbox"/> D
TORRO 7010 L / D	<input type="checkbox"/>	<input type="checkbox"/>	<input type="checkbox"/>	<input type="checkbox"/> D
TORRO 8010 L / D	<input type="checkbox"/>	<input type="checkbox"/>	<input type="checkbox"/>	<input type="checkbox"/> D

= optional



MyPÖTTINGER

Your machine goes online.

All the information on your machine
easily – anytime – anywhere

Simply scan the QR code on the **data plate** with your smartphone or tablet or enter your machine number at www.mypoettinger.com. You will immediately receive all the information on your machine.

- Operating instructions
- Optional equipment information
- Brochures
- Photos and videos



PÖTTINGER Original Parts

PÖTTINGER Spare parts service

- Worldwide network of sales and service partners.
- Decades of spare and wear parts availability.
- Original PÖTTINGER parts can be ordered online around the clock.

PÖTTINGER Landtechnik GmbH

Industriegelände 1
4710 Grieskirchen
Austria
Phone +43 7248 600-0
info@poettinger.at
www.poettinger.at

Alois PÖTTINGER UK Ltd.

15 St Marks Road, Corby
Northamptonshire,
NN18 8AN
United Kingdom
Phone + 44 1536 272 220
info@pottinger.uk
www.pottinger.uk

POETTINGER Canada Inc.

460 Rue Robinson Sud
Granby, QC, J2G 7N6
Canada
Phone +1 450 372 5595
Fax +1 866 417 1683
info@poettinger.ca
www.poettinger.ca

POETTINGER US, Inc.

393 Pilot Drive
Valparaiso, IN 46383
USA
Phone +1 219 510 5534
Fax + 1 219 707 5412
info@poettinger.us
www.poettinger.us

PÖTTINGER Australia PTY LTD

11 Efficient Drive
Truganina VIC 3029
Australia
Phone +61 3 8353 2770
info@poettinger.com.au
www.poettinger.com.au

POETTINGER Ireland Ltd.

Glenaleamy, Powerstown Road,
Clonmel, Co. Tipperary
Ireland
Phone +353 52 6125766
info@poettinger.ie
www.poettinger.ie

Importer for New Zealand:

Origin Agroup
PO Box 673, 57 Hautapu Road
Cambridge
New Zealand
Phone +64 7 823 7582
info@originagroup.co.nz
www.originagroup.co.nz

Importer for South Africa:

VALTRAC
Cnr. Water & Buiten Street
9585 Parys
South Africa
Phone +27 56 817 7338 7308
wynn@valtrac.co.za
www.valtrac.co.za

