

TOP

PÖTTINGER rakes





Rakes for every application

Smooth running PÖTTINGER rakes with perfect ground tracking and excellent manoeuvrability meet the high demands of the industry. Rakes with the lowest disintegration losses and minimal soil accumulation guarantee energy rich forage and efficient use of base forage.

Contents

	Page
TOPTech PLUS	4
TOP tines	6
Single rotor rakes	8
Twin rotor rakes	14
MULTITAST jockey wheel	16
TOP rotor chassis	18
Twin rotor rakes with centre swath placement	20
Twin rotor rakes with side swath placement	28
Twin rotor rakes without additional chassis	32
Four rotor rake with centre swath placement	36
Technical data / Equipment	40

All information on technical data, dimensions, weights, output, etc. is approximate and is not binding.

TOPTECH PLUS

Impressive rotor technology

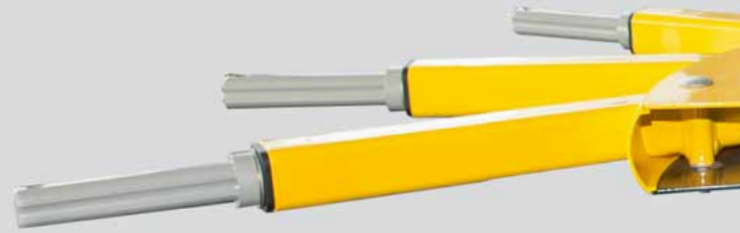

The large cam tracks on PÖTTINGER rakes offer a cam track diameter of up to 16.54" / 420 mm and a bearing spacing of up to 35.43" / 900 mm on the tine arms. These properties give the tine arms maximum strength with minimum stress on the arm bearings. The cam track can be infinitely adjusted to different forage volumes and changing harvesting conditions.

The rotor drive gears run in a sealed semi-liquid grease gearbox.

Rotor unit is encapsulated and dust-tight

No oil required. TOPTECH PLUS eliminates leak problems and requires neither oil checks or changes.

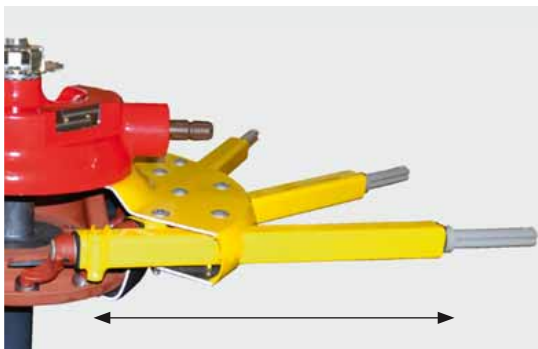

Maximum uptime and durability

The large diameter cam track with its smooth ramps ensures the tines exit the swath cleanly.

Maintenance free steel cam rollers, high strength cam arms and wide spacing of the tine arm bearings guarantee high strength and low stress for the bearings. The tine arm bearings are sealed and maintenance free.

The heavy duty tine arm cross section is strong and resistant to twisting and bending. Tidy raking is provided by 10 to 15 tine arms per rotor, depending on the working width. The tine arms are removable to reduce height for transport and parking.





Service friendly rotor technology

The whole tine arm can be exchanged quickly and easily in the event of any damage. Just undo two bolts to slide the inner tine arm and roller out of the rotor casing.

- No problems with oil leaks.
- Ready for action again in no time.

	Tine arms per rotor	Rotor Diameter	Cam track Diameter	Tine arm bearing spacing
TOP 342	10	9.19 ft / 2.80 m	13.78 in / 350 mm	11,81 in / 300 mm
TOP 382	11	9.84 ft / 3.00 m	13.78 in / 350 mm	11,81 in / 300 mm
TOP 422	12	10.83 ft / 3.30 m	16.54 in / 420 mm	23.62 in / 600 mm
TOP 462	12	12.14 ft / 3.70 m	16.54 in / 420 mm	27.56 in / 700 mm
TOP 421 A TOPTECH PLUS	12	10.76 ft / 3.28 m	16.54 in / 420 mm	23.62 in / 600 mm
TOP 461 A TOPTECH PLUS	12	11.81 ft / 3.60 m	16.54 in / 420 mm	27.56 in / 700 mm
TOP 612	11	9.25 ft / 2.82 m	13.78 in / 350 mm	17.72 in / 450 mm
TOP 612 C	11	9.19 ft / 2.80 m	13.78 in / 350 mm	17.72 in / 450 mm
TOP 702 C	11	10.07 ft / 3.07 m	13.78 in / 350 mm	17.72 in / 450 mm
TOP 762 C CLASSIC	11	10.83 ft / 3.30 m	16.54 in / 420 mm	23.62 in / 600 mm
TOP 762 C	13	10.83 ft / 3.30 m	16.54 in / 420 mm	23.62 in / 600 mm
TOP 842 C	13	12.14 ft / 3.70 m	16.54 in / 420 mm	27.56 in / 700 mm
TOP 962 C	15	14.11 ft / 4.30 m	16.54 in / 420 mm	35.43 in / 900 mm
TOP 611 A TOPTECH PLUS	12	9.78 ft / 2.98 m	16.54 in / 420 mm	23.62 in / 600 mm
TOP 691 A TOPTECH PLUS	12	10.76 ft / 3.28 m	16.54 in / 420 mm	23.62 in / 600 mm
TOP 652	10 + 12	10.33 + 9.84 ft / 3.15 + 3 m	13.78 in / 350 mm	17.72 in / 450 mm
TOP 662	12	10.07 ft / 3.07 m	13.78 in / 350 mm	17.72 in / 450 mm
TOP 722	13	10.83 ft / 3.30 m	16.54 in / 420 mm	23.62 in / 600 mm
TOP 812	13	12.14 ft / 3.70 m	16.54 in / 420 mm	27.56 in / 700 mm
TOP 1252 C	13	10.83 ft / 3.30 m	16.54 in / 420 mm	27.56 in / 700 mm

TOPTECH PLUS

The best forage



Raking has a decisive influence at the end of the harvest chain on how clean the forage remains. The tines must not contact the ground; instead they should rake the forage carefully out of the sward.

TOP tines deliver millimetre precision

The tines point straight at the ground directly under the tine arm, without any need for a steep offset angle. Due to the resistance of the forage, they are pressed back slightly but do not rise away from the ground so the tines produce exact raking results.

These tines do not need to be set as deep to rake tidily, as a result this means less stress on the cam track and cam rollers.

The long tines are drawn smoothly out of the swath for a perfect swath shape. The sward and forage are both treated with care.

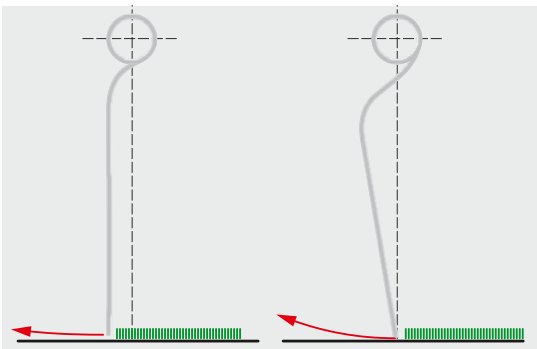

Easy height adjustment

The working height of TOP rakes can be adjusted from the standing position using a hand crank. This is easily accessible and maintenance-free.

A height indicator makes it easy to ensure that both rotors are the same height on twin rotor rakes.



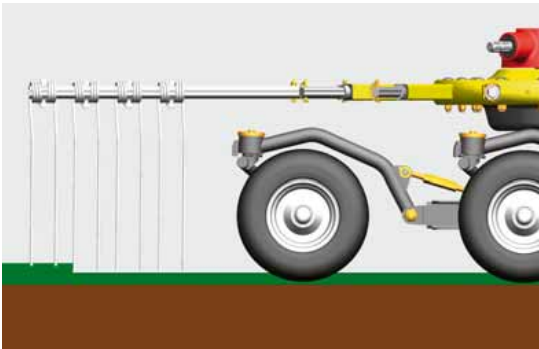

Multi-stage raking

The outer pairs of tines are slightly shorter so that they do not contact the full volume of forage and the load is lower. The three inner pairs of tines are used for precision work.

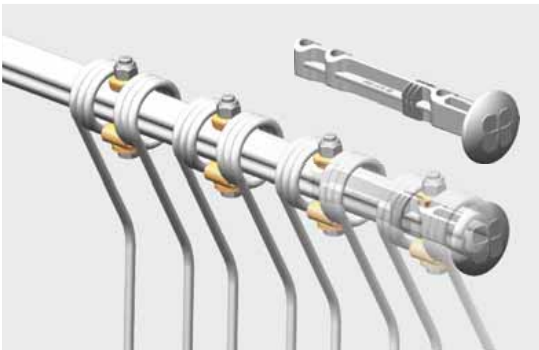

Securely bolted

Featuring a profiled support plate, the tine mounting provides a secure connection.



Safe and sound

Tine security system

The tine security system prevents tine loss in the swath. The tine saver is secured reliably over the outermost tine bolt.

Unbeatable tine arm profile

Extremely resistant to twisting and bending forces, which are dissipated away from the centre of the rotor. The lynch pin is only a security measure, easy to slot in, it is not possible to fit the wrong way. The inner tine pairs are also easy to install, thanks to the tine arm design. All tine arms can be removed to save space when stored through the winter.



Single rotor rakes

Lightweight and manoeuvrable



3-point linkage

TOP 342 / TOP 382 / TOP 422 / TOP 462

Our single rotor rakes with working widths of 11.15 to 15.09' / 3.40 m to 4.60 m are ideal for smaller areas.

TOP 342 – The lightweight

The TOP 342 with its working width of 11.15' / 3.40 m weighs in at just 1045 lbs / 474 kg and is therefore perfect for working on slopes.

Optimised ground tracking and careful forage handling are trademarks of TOP rakes.



Trailed single-rotor rakes

High performance with smaller tractors

TOP 421 A TOPTECH PLUS / 461 A TOPTECH PLUS

For big performance with smaller tractors, there are two single-rotor rakes also available as trailed versions. The drawbar is equipped with a large support plate to provide extra stability on slopes and when cornering.

The unit is raised hydraulically for transport via hydraulic cylinders on the chassis and drawbar which provide 19.68" / 500 mm of ground clearance.

- Working widths 13.78 or 15.09' / 4.20 or 4.60 m.
- The tandem axles are fitted with 18.5 x 8.5-8 flotation tyres as standard.



Best ground tracking



Stabiliser struts to keep steady

Stabiliser struts on both sides ensure the rake is always centred. The stabiliser struts keep the rake straight even when operating across slopes, when raised and during transport. The stabiliser is fully adjustable.



Pivoting headstock

For optimum cornering

- Rakes with pivoting headstocks follow in the tractor's tracks without uncontrolled swinging from side to side.
- The pivoting headstock with heart-shaped pivot pin brings the machine into the centre position when it is raised to optimise ground clearance.
- A slotted hole is provided for operation with a jockey wheel and rigid top link.
- Two positions for the lower linkage arms ensure that there is always sufficient lifting clearance.
- A practical PTO shaft holder and hose tidy makes coupling and uncoupling a great deal easier.
- The transport interlock enhances safety on the road.



Wide chassis

Wide axles and large tyres close to the tine contact point guarantee the best ground tracking. No skipping or scraping over bumps or on slopes.



For the last 30 years we have always been one wheel ahead!

If it's been working effectively this long, it must be good; TOP rakes with an additional MULTITAST jockey wheel track the contours of the ground and rake very tidily. The extra wheel always leads the way, this top guidance with the MULTITAST jockey wheel is especially useful on rough ground.

- Delivering the best ground tracking and tidy raking work even in demanding operating conditions.
- The tines do not scrape the ground, even in undulating terrain.
- The tines last longer, the sward is conserved and the forage remains clean.

Flexible mounting for MULTITAST wheel

The optional jockey wheel can be mounted in a range of positions via the bolted mounting on the headstock.

Many TOP owners are impressed: "The third wheel makes all the difference on every terrain, producing significantly lower soil content in the forage".

TOP tandem axles

TOP raking work, high driving speed, full power

- Four large flotation tyres even out bumps in the ground perfectly.
- The axle floats in the centre. If a wheel is lifted by 3.94" / 100 mm, the axle only lifts the rake by 1.97" / 50 mm.
- On PÖTTINGER tandem axles you can also adjust the rotor sideways pitch, making this raking technology for professionals.

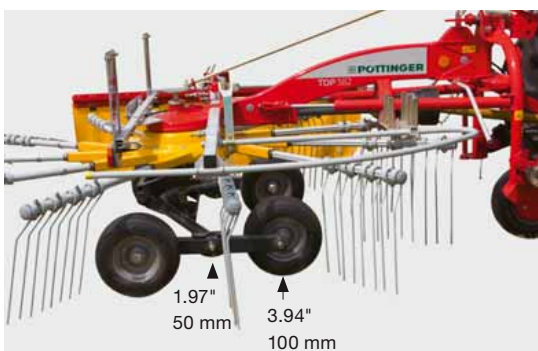

Convenient to use



Adjustable quickly and conveniently

It's a question of the right setting, mere millimetres determine the quality of the forage. A range of adjustments help you to find the ultimate working setting.

Working height – Exact adjustment

The working height is adjusted using a hand crank. Smooth running and maintenance free, it can be operated without bending down.

Tandem axles – Precision adjustable and easy to retrofit

The rotor sideways pitch is adjusted using the offset bolts on the wheels. For perfect raking work, the rotor should be angled slightly towards the swath. Quick and easy to retrofit.

Swath curtain adjustment – Infinitely variable

The swath curtain can be adjusted to match the quantity of forage and the desired width of the swath.

Mechanical swath curtain lifting

A spring loaded strut makes it easy to lift the swath curtain.

Hydraulic swath curtain lift system

Lifting conveniently from the tractor seat is also available as an option.





Narrow, safe road transport and space saving

Changing to the road transport position has got to be quick.

- Remove lynch pins
- Remove tine arms
- Insert onto the holders

The tines are stowed away tidily and secured in place by lynch pins. After folding the guard rail vertically, the TOP is ready for road transport. Warning signs and road lights are standard.

The TOP 342 and TOP 382 with mechanical swath curtain lifting achieve a transport width of less than 9.84' / 3.00 m without removing tine arms.





Twin rotor rakes

Model overview



Centre swath rakes

TOP 612

Linkage mounted with pivoting three-point headstock

Working width 19.36' / 5.90 m. For areas where access can be restricted.

TOP 612 C / 702 C / 762 C / 762 C CLASSIC

Trailed rake with separate chassis

Working widths from 19.36 to 24.61' / 5.90 to 7.50 m.

The advantage of our centre-swath rakes is their uniform and airy swath placement.

TOP 842 C / 962 C

The big traileed centre-swath rakes

Working widths from 25.26 to 31.50' / 7.70 m to 9.60 m.

TOP 842 C with a transport height below 13.12' / 4.00 m without removing tine arms.



Side rake

TOP 652 / 662 / 722 / 812

Trailed side rake with separate chassis

Working widths from 21.0 to 24.93' / 6.40 to 7.60 m.

TOP side rakes can easily be adapted to different crop conditions and harvesting technology. The swath is formed on the right hand side to enhance ergonomics.

TOP 611 A TOPTECH PLUS / TOP 691 A TOPTECH PLUS

Trailed side rake without additional chassis.

Working widths from 11.15 to 22.64' / 3.40 to 6.90 m.

These twin rotor rakes are highly popular due to their attractive price and excellent manoeuvrability.



MULTITAST jockey wheel

Good guidance guarantees
the best forage quality

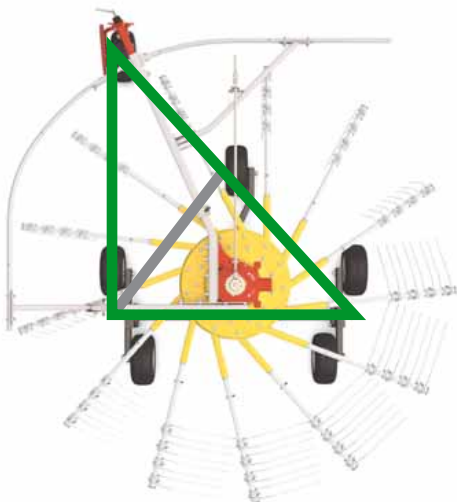

With MULTITAST wheel

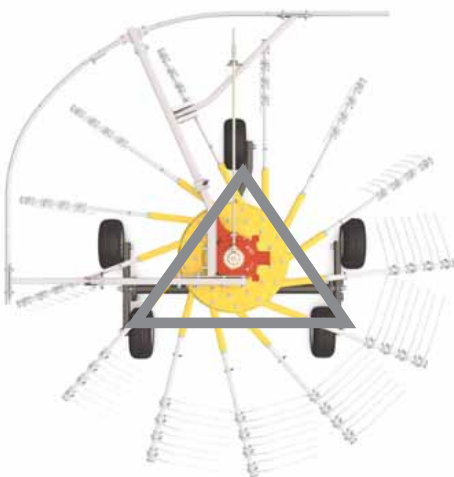

Without MULTITAST wheel

The MULTITAST wheel from PÖTTINGER supports quality aware farmers to achieve the highest objective in forage harvesting: Clean forage for healthy, high yielding animals. At the same time, the valuable sward is protected.

Offset in front of the rotor, the wheel ensures perfect ground tracking without the tines contacting the ground. The PÖTTINGER MULTITAST wheel ensures high working quality and productivity.

Reliable rotor guidance

The MULTITAST wheel makes the support triangle much larger. This makes the rotors run more smoothly and suppresses vibrations. The PÖTTINGER MULTITAST wheel provides ground tracking and guarantees clean forage without disintegration losses.

Rake without MULTITAST wheel

Without a MULTITAST wheel the rake has a much smaller area of support. This leads to a less smooth operation with reduced ground tracking, which can cause crop contamination.



DLG confirms forage protection and smooth running

The DLG Focus Test “Ground tracking and forage contamination in grass silage” in November 2013 confirms: The PÖTTINGER MULTITAST wheel delivers ideal ground tracking and clean forage.

Clean forage

The MULTITAST wheel ensures smooth running of the rotors and suppresses oscillations.

On a rise, the MULTITAST wheel lifts the rotor. The ideal gap between the tines and the ground is maintained. Clean forage is guaranteed.

- Over a test track of 65.6 yard / 60 m, the tines on the rotor without the MULTITAST wheel contact the ground at least 5 times more (see image).

On top of a rise, the MULTITAST wheel guides the rotor downwards and prevents raking losses.

- Over the same test track, the tines on the rotor without the MULTITAST wheel rise above the crop three times, resulting in raking losses (see image).

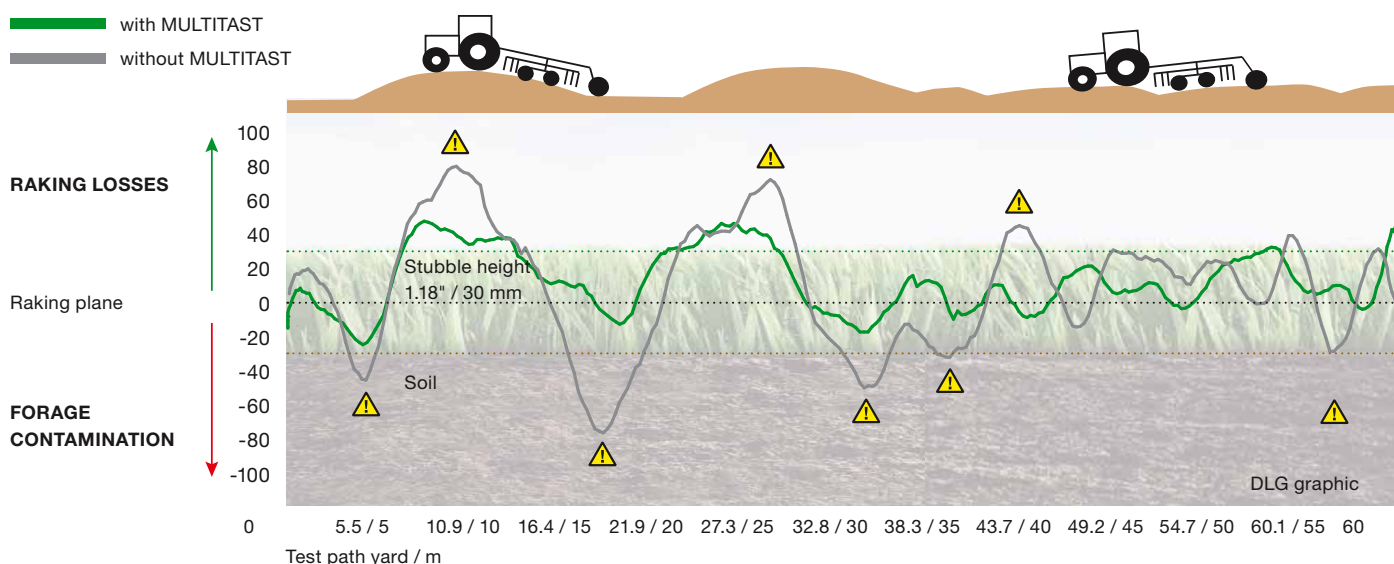

Chassis

Masters of ground tracking

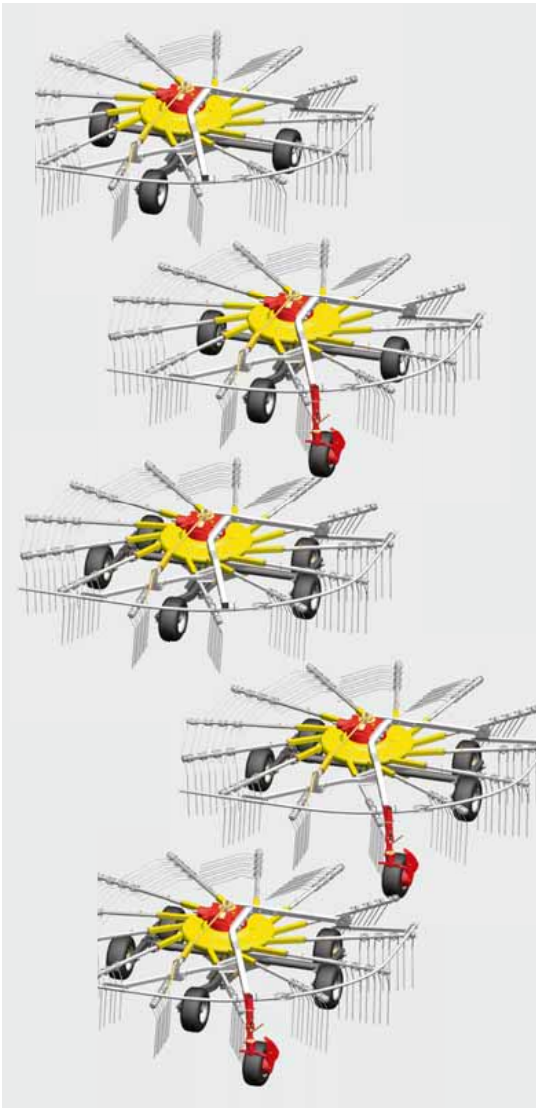

A rotor chassis for every application

For tidy and careful raking, PÖTTINGER offers four options on twin rotor rakes to best match your operating conditions.

Three wheel chassis

Tidy raking work on level surfaces at normal speed. Standard on the TOP 612 C / TOP 702 C / TOP 762 C CLASSIC / TOP 662.

Three wheel chassis with MULTITAST wheel

The MULTITAST jockey wheel system guarantees tidy work even on rough ground at normal speed.

Five wheel chassis with tandem axle

Tidy raking work on level surfaces at high speed.

Standard on the TOP 762 C / TOP 842 C / TOP 722 / TOP 812.

A six wheel chassis with tandem axles is standard equipment on the TOP 962 C.

Tandem wheel chassis with MULTITAST Wheel

Standard equipment on the TOP 652.

Five or six wheel chassis with tandem axles and MULTITAST jockey wheel

The best ground tracking in every terrain and completely smooth running at the highest driving speed.



TOP rakes stand for working quality and productivity. Perfect ground tracking is the guarantee for tidy raking work, even in short, heavy or damp forage.

TOP tandem axes

Even on undulating and rough terrain, we can guarantee you perfect raking performance and clean forage. The tandem axes provide a very wide wheel spacing which makes the rake perform very well on slopes. The wheels are located very close to the tines.



Tandem axes – Precision adjustable and easy to retrofit

The rotor pitch is adjusted using the offset bolts on the wheels. For perfect raking work, the rotor should be angled slightly towards the swath. Quick and easy to retrofit.

MULTITAST jockey wheel

Perfect raking

The MULTITAST wheel offered by POTTINGER over the last three decades offers you the ultimate goal in raking; clean forage for healthy, high yielding animals. At the same time the sward is protected. Offset in front of the rotor, the wheel ensures perfect ground tracking without the tines contacting the ground. The service life of the cam rollers and tines are also extended as a result.





Centre swath placement

TOP 612 / 612 C



The entry level model

TOP 612 linkage mounted rake

Offering a working width of 19.36" / 5.90 m this compact three point linkage mounted model is ideal for areas where access is an issue. The pivoting headstock design ensures the rake follows the tractor when cornering and is locked securely via hydraulic cylinder when the rotors are raised.

Stabiliser struts on both sides are standard equipment; with tandem axles available optionally.

Being able to store the TOP 612 in its transport position really saves space and tine arms can be removed to reduce overall height. The handy parking wheels make it easy to hitch up and manoeuvre.

Tidy raking

The floating rotor arms allow the rotors to track the ground effectively offering clean and careful raking.

Half working width

If required, it is also possible to rake with only one rotor.

TOP 612 C trailed centre swath rake with chassis

The fixed working width of 19.36' / 5.90 m produces a 3.28' / 1.00 m wide swath.

On the trailed TOP 612C model an optional steering axle is available. Fitted with optional 10/75-15.3 AS tyres, this rake is especially suitable for working on slopes.



Centre swath placement

With steered chassis



The classic models

TOP 702 C / TOP 762 C CLASSIC / TOP 762 C

Compact mounting

The machine is connected to the tractor by a yoke type headstock that enables a turning angle of 73°. The heavy duty frame is designed for the toughest operation conditions.

A practical PTO shaft holder and hose tidy are standard equipment for uncluttered storage. A freewheel is integrated into the second PTO shaft on the driveline. Lubrication intervals are 50 hours.

Maximum manoeuvrability

Thanks to the steered axle, TOP centre swath rakes are extremely manoeuvrable. The steering angle indicator is clearly visible from the driver's seat. A strong steering linkage between the headstock and the axles features maintenance free steering linkage joints. The Ackermann steering allows a shorter construction and thus the machine is more manoeuvrable following the tractor better than with axle pivot steering.



Customised axles

- A 8.37' / 2.55 m track width is available as an option for an especially narrow transport width.
- The chassis is fitted with large tyres, standard 260/70-15.3 – Optional 340/55-16 or 380/55-17.
- AS profile 10/75-15.3 tyres are available as an option to make these rakes especially suitable for slopes.
- Lights and mudguards are fitted as standard.



Convenient to use



Working widths as required

TOP 762 C CLASSIC

The working width is fixed at 22.47' / 6.85 m to form a swath 3.94' / 1.20 m wide.

TOP 702 C / TOP 762 C

We offer two possibilities for adjusting the working width to match the swath precisely to your requirements. The optional swath curtain guarantees perfect swath shape.



Mechanical adjustment

A turnbuckle is used to adjust the working width and is the ideal solution for farms where the width only needs to be changed occasionally. The width of the swath can be varied between 3.94 and 6.56' / 1.20 and 2.00 m.

Hydraulic adjustment

With the optional hydraulic adjustment system, it is possible to place a narrow swath without using a swath curtain. The whole crop lucerne, for example is raked right through – TOP 702 C / TOP 762 C.

- Infinitely variable adjustment from the tractor seat.
- Optimum match to any pick-up width.



Hydraulic adjustment of the working width is a convenient solution if the swath often needs to be adapted to the width required for the follow-up machine. The swath width indicator helps you achieve the right setting. The optional hydraulic working width adjustment system requires a double-acting connection.



Convenient operation from the tractor seat

One single-acting connection to the tractor hydraulics is all that is needed for lifting.

A flow splitter is available as an option to raise the rotors evenly. This is an advantage especially on slopes. Stabiliser springs on the rotors ensure that they are lifted and lowered gently at the headland. Optionally available is a swath curtain which automatically raised when the rotors are lifted.



An individual rotor lifting system with electrical preselect is available for raking headlands and final passes that only need one rotor width.



Transport height less than 13.12' / 4 m

Offering a transport height of less than 13.12' / 4.00 m there is no need to leave the tractor cab to remove tine arms before driving to the next field.

- Overall heights with tine arms removed 9.58, 10.83 or 11.48' / 2.92, 3.30 or 3.50 m.
- Warning signs and road lights are standard.



Large twin rotor rakes

TOP 842 C / 962 C



The highest performance models

Professional class centre-swath rakes with hydraulically adjustable working widths
TOP 842 C from 25.26 to 27.56' / 7.70 to 8.40 m – TOP 962 C from 29.20 to 31.50' / 8.90 m to 9.60 m.

Good guidance guarantees best forage quality

The MULTITAST jockey wheel in conjunction with the five-wheel chassis inside the arc of the tines ensures smooth running of the rotors and suppresses oscillations (six wheel chassis is standard on TOP 962 C). Suspension springs ensure that the rotors run smoothly in the working position.

Adjustable lifting clearance

The headland lifting clearance can be adjusted on demand using a valve for limiting the lifting height.

Maximum uptime and durability

The TOPTECH PLUS rotor units deliver impressive performance thanks to their large bearing spacing (27.56 or 35.43" / 700 or 900 mm) and dust tight encapsulation.

High output for straw

Thanks to the offset MULTITAST jockey wheels outside the tine arc, the TOP 842 C / TOP 962 C are ideal for turning or merging straw swaths. If required, the MULTITAST jockey wheels can simply be removed.



Convenient operation from the tractor seat

One single-acting connection to the tractor hydraulics is all that is needed for lifting.

A flow splitter is fitted as standard to raise the rotors evenly. This is an advantage especially on slopes.

The optional swath curtain raises automatically with the rotors.

An individual rotor lifting system with electrical preselect is available for raking headlands and final passes that only need one rotor width.

This system also includes a pushbutton for folding the rake into the transport position doing away with the need for a rope lanyard controlled latch.



Safe transport

The hydraulic working width adjustment system is also used for raising the rake into the transport position. The mechanical safety interlock engages automatically.



TOP 842 C / 962 C

- Transport height with tine arms fitted 13.09 or 15.09' / 3.99 or 4.60 m.
- Transport height with tine arms removed 11.48 or 12.96' / 3.50 or 3.95 m.
- The chassis is fitted with large tyres, standard 340/55-16 – optional 380/55-17.
- AS profile 10/75-15.3 tyres are available as an option to make these rakes especially suitable for slopes.
- Lights and mudguards are fitted as standard.
- Air brakes or hydraulic brakes are optional on the TOP 962 C.



Side swath placement

TOP 652 / TOP 662 / TOP 722 / TOP 812



Straightforward connection

The lower linkage drawbar of the TOP 722/TOP 812 allows for a very tight turning circle. Equipped with a double wide angle PTO shaft c/w freewheel and steering angle indicator the tightest of turns can be accommodated. Lubrication intervals of 50 hours, a PTO shaft holder and hose tidy supplied as standard allow for easy operation. The TOP 622 is attached via a yoke type headstock.



Transport height under 13.12' / 4 m

On the TOP 722 the rotors are moved into the transport position via control levers. On the TOP 812, this is performed by hydraulic cylinders.

- A transport height of below 13.12' / 4.00 m without removing tine arms.
- The swath curtain folds automatically for a transport height under 3.12' / 4.00 m.
- You can drive to the next field without leaving the tractor cab.
- Overall height with tine arms removed 11.81' / 3.60 m.
- The chassis is equipped with 340/55-16 tyres.
- A 8.37' / 2.55 m track width is available as an option for especially narrow transport widths. (9.22' / 2.61 m transport width on TOP 722).
- Warning signs and road lights are standard.



New: TOP 652

The low cost entry level alternative side delivery rake with steering. Rotors with 10 & 12 tine arms giving left-hand swath placement and a fixed working width of 21.0' / 6.40 m.



Perfect ground tracking

Five-wheel chassis as standard

Combined with cardanic rotor suspension, the standard five-wheel chassis on the TOP 722 and TOP 812 ensures precise guidance of the tines over every contour.

Tandem axles

The tandem axles are equipped with 16x6.5-8 tyres, pivoting at the front and rigid at the back. Thanks to the adjustable tandem axles, the rotor pitch can be quickly matched to all operating conditions.

MULTITAST

Optional MULTITAST wheels are especially recommended for working in undulating terrain. The MULTITAST wheels run in front of the tines to make sure that they do not contact the ground.

Stabiliser springs

Weight alleviation springs are fitted to the rotors as standard to ensure that they are lifted and lowered at the headland without contacting the ground.

Suspension springs

As an option, additional suspension springs provide ground level protection for particularly difficult terrain.





Easy operation

Only one double-acting spool valve with a float position is required for the TOP 722; two double-acting spool valves are required for the TOP 812.

16.93" / 430 mm ground clearance

Optimised folding geometry on the TOP 722 and TOP 812 provide up to 16.93" / 430 mm of ground clearance at the headland. As a result, damage to previously made swaths is safely avoided.



Double cylinder technology

On the TOP 722 / TOP 812 models, double cylinder systems are used to lift the rotors so no stop position is required in the field. The rotor is lifted and lowered using matrix-controlled valves, offering real sequential control. The lifting height can be adjusted whenever needed.



Dual swath function

Optional dual swath function with a front swath curtain for TOP 662 and TOP 722. Instead of using linkage levers, the rotors are moved in and out using double-acting hydraulic cylinders.

When using two swaths the working width is 23.95 or 24.93' / 7.30 or 7.60 m; with one swath it is 21.49 or 22.31' / 6.55 or 6.80 m.





POTTINGER
www.pottinger.at

25 km

Twin rotor rakes

TOP 611 A TOPTECH PLUS / TOP 691 A TOPTECH PLUS
without additional chassis



These twin rotor rakes are highly popular due to their attractive price and excellent manoeuvrability. These side rakes can be flexibly configured to rake a large single swath or two narrow swaths.

Optimum flexibility

The hydraulic working width adjustment system enables the formation of a single swath or a dual swath.

Forming one side swath

The machine is offset so that the rear rotor accepts the forage from the front rotor. This configuration produces a single swath with the front swath curtain raised.

Forming two swaths or night swaths

If the rear rotor is pivoted to the right and the front swath curtain is lowered each rotor forms its own swath. This makes it possible to form two small night swaths, or two larger swaths in the case of very high forage volumes.





Perfect ground tracking

The drawbar is equipped with a large clevis support plate to provide extra stability on slopes and when cornering.

The frame is designed so that the two rotor units can ride over uneven ground completely independently of each other. Vertical freedom of movement is provided by a joint directly behind the angular gearbox.

Transverse movement of the rear rotor unit is enabled by a pivot bearing mounted within the frame itself, and by a universal joint between the rear frame beam and the rotor unit.



Enjoy the road trip

- The tandem axles are also used as the transport chassis.
- 18 x 8.5-8 flotation tyres enable high travelling speeds.
- The wide chassis provides the best stability on slopes.
- The rotors are lifted hydraulically to drive over swaths and at headland turns.
- Ground clearance of 19.69" / 500 mm.
- When in the transport position it is easy to access the working height adjustment under the rotor.
- Warning signs and road lights are standard.





Easy operation

One single-acting connection to the tractor hydraulics is all that is needed for lifting. Hydraulic working width adjustment for a single swath or dual swaths is possible with one double-acting connection.

Stepping valves provide more convenient operation for raising and lowering the rotors.

The hydraulic working width adjustment system can also be used to steer at the headland and enables perfect manoeuvrability.

The unit is raised hydraulically for transport. Hydraulic cylinders on the chassis and drawbar provide 19.69" / 500 mm of ground clearance.

Hydraulic swath curtain lift system

With optional hydraulic swath curtain lifting, the TOP 611 A TOPTECH PLUS has a transport width of less than 9.84' / 3.00 m without having to leave the cab to remove the tine arms.

Four rotor rake

TOP 1252 C



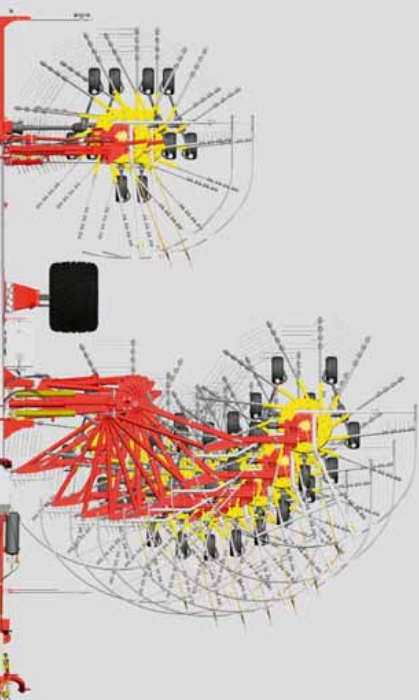

TOP 1252 C centre swath

Avoiding a backlog during harvesting demands high-performance agricultural technology. The performance of silage trailers and self-loading wagons can be increased by up to 20% if the swath is of optimal shape and uniform density.

Unique hybrid drive

PÖTTINGER has developed a unique hybrid drive technology: four-rotor rake.

- Hydraulic drive at the front, mechanical drive at the rear.
- The working width can easily be adjusted from 26.3 to 41.0 ft / 8.0 to 12.50 m.
- Raking around obstructions is no problem.
- The raking width can even be adjusted while working thanks to the pivot wheels.

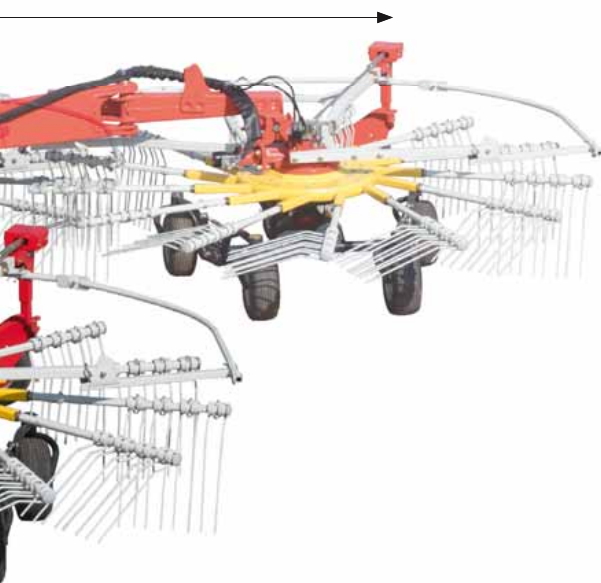

TOPTECH PLUS

This impressive and proven rotor technology from PÖTTINGER is now also integrated in the four rotor rake.

- The whole tine arm can be exchanged quickly and easily in the event of any damage.
- Just undo two bolts to slide the inner tine arm and roller out of the rotor casing.
- No problems with oil leaks.
- Ready for action again in no time.

TOP 1252 C

Four rotor rake – centre swath



From the field to the road without leaving the cab

- The hydraulic drive of the front rotors enables the extending arms to be pivoted inwards for a transport height of only 13.12 ft / 4.0 m without removing tine arms or folding safety guards. Annoying setup times are therefore a thing of the past.
- Large dimensioned 500/50-17 tyres minimise pressure on the ground in the field while maximising driving comfort on the road. Optionally available are 620/40 R 22,5 or 710/35 R 22,5 tyres.
- Choose between pneumatic or hydraulic brakes.
- Mechanical interlock and support for safe road transport.

Tidy and protective raking

PÖTTINGER ground hugging technology meets the very highest expectations. There is no better solution. The result is tidy raking work at the same time as protecting.

- The tandem axles are fitted with large 16 x 6.5-8 pivoting wheels.
- Pentagonal chassis (5 wheels) for inside the sweep of the tines are standard.
- The MULTITAST ground hugging wheels with anti-wrap guards can be fitted as an option and – together with the floating rotor suspension – guarantee precision guidance of the tines over undulations.
- Because the tandem axles are adjustable, the angle of the rotors can be adjusted precisely to the operating conditions in just a few minutes.



TOP forage quality. TOP milk yield.

- Raw ash content with MULTITAST wheel: 10.1 %.
- Raw ash content without MULTITAST wheel: 12.4 %.
- 2.3 % more raw ash means 184 lbs soil per acre / 207 kg per ha for a yield of 8025 lbs DM per acre / 9 t per ha.
- Rotors equipped with the MULTITAST wheel prevents contamination with a 25 % reduction in raw ash/contamination in the forage.



Operating comfort

- Standard models require one double-acting remote for lifting the rotors and two double-acting remotes for adjustment of the working width.
- The convenient electronic POWER CONTROL terminal is available as an option for lifting the rotors individually and adjusting the rotor height hydraulically.
- For a wider range of function and control the CCI ISOBUS terminal with all functions of POWER CONTROL and more is available.





TOP 342

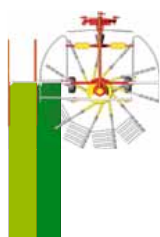

Swath width
1.48' – 5.41'
0.45 m – 1.65 m

TOP 382

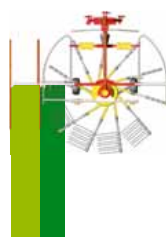

Swath width
1.97' – 5.41'
0.60 m – 1.65 m

TOP 422

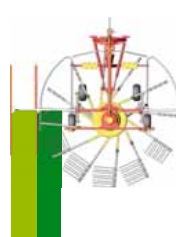

Swath width
1.97' – 5.41'
0.60 m – 1.65 m

TOP 462

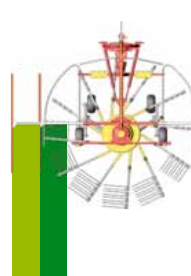

Swath width
1.97' – 5.41'
0.60 m – 1.65 m

TOP 461 A / 461
TOPTECH PLUS

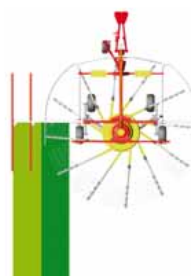

Swath width
1.97' – 5.41'
0.60 m – 1.65 m

TOP 611 A TOPTECH PLUS
TOP 691 A TOPTECH PLUS

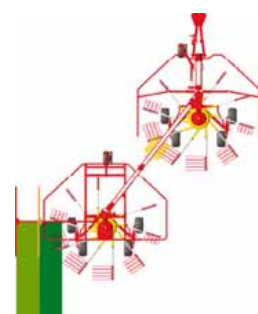

Swath width
1.97' – 6.23'
0.60 – 1.90 m

TOP 612

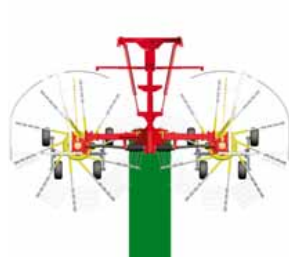

Swath width
3.28' / 1.00 m

TOP 612 C



Swath width
3.28' / 1.00 m

TOP 702 C

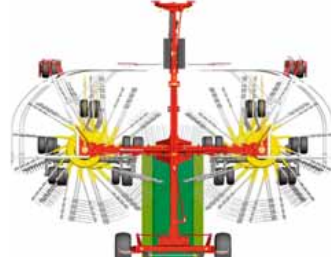

Swath width
3.28' – 5.91'
1.00 – 1.8 m

TOP 762 C
CLASSIC

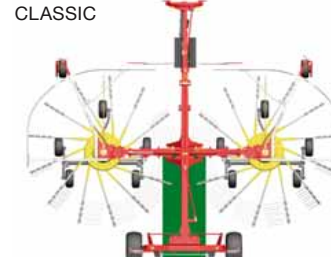

Swath width
3.94' / 1.20 m

TOP 762 C

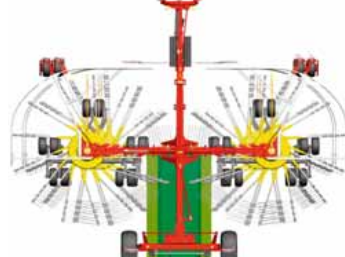

Swath width
3.61' – 6.56'
1.10 m – 2.00 m

TOP 842 C

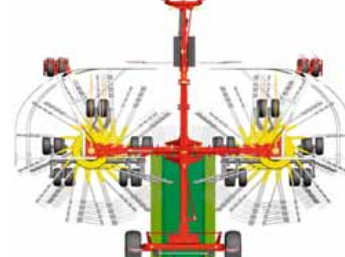

Swath width
4.27' – 7.23'
1.30 m – 2.20 m

TOP 962 C

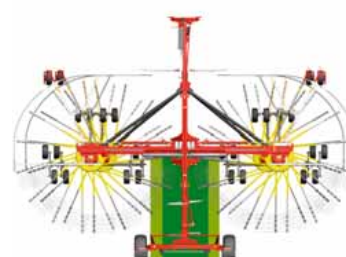

Swath width
4.27' – 7.23'
1.30 m – 2.20 m



TOP 611 A TOPTECH PLUS
TOP 691 A TOPTECH PLUS



Swath width
1.97' – 6.23'
0.60 – 1.90 m

TOP 652

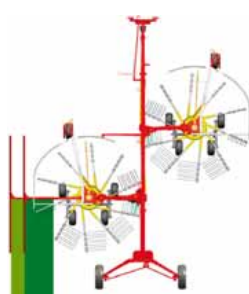

Swath width
3.28' / 1 m

TOP 662 / TOP 722

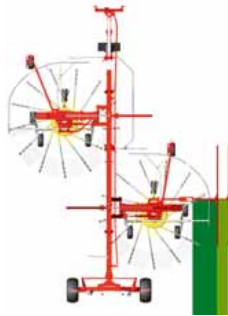

Swath width
3.28' – 5.91'
1.00 – 1.80 m

TOP 662 / TOP 722

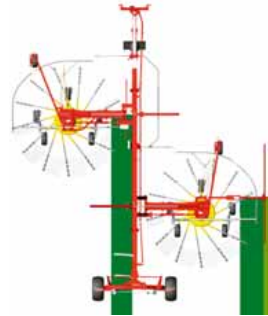

Swath width
3.28' / 1.00 m

TOP 812

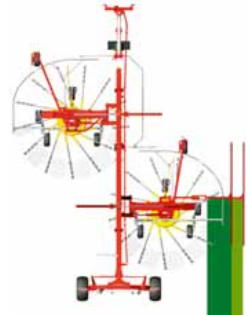

Swath width
3.28' – 5.91'
1.00 – 1.80 m

TOP 1252 C

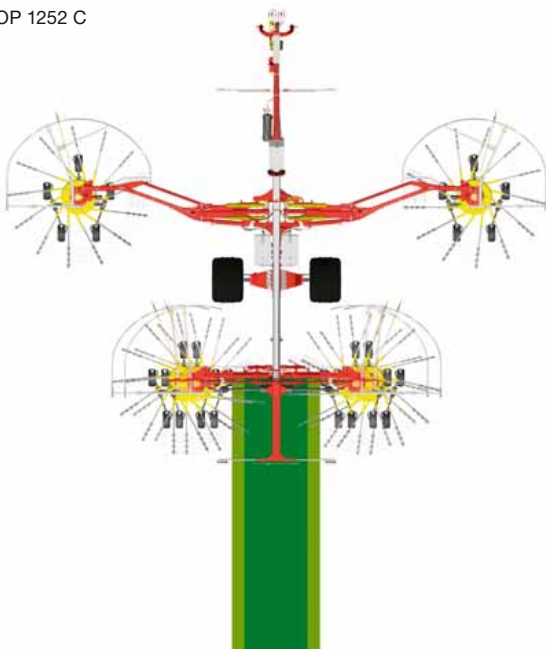

Swath width
4.27' – 7.23'
1.30 m – 2.20 m

Technical data

Single rotor rakes Side rake	Standard working widths	Working widths hydraulic	Arms per rotor	Rotor unit tyres
TOP 342	11.15' / 3.40 m	–	10	16 x 6.5-8
TOP 382	12.47' / 3.80 m	–	11	16 x 6.5-8
TOP 422	13.78' / 4.20 m	–	12	16 x 6.5-8
TOP 462	15,09' / 4.60 m	–	12	16 x 6.5-8
TOP 421 A TOPTECH PLUS	13.78' / 4.20 m	–	12	18.5 x 8.5-8
TOP 461 A TOPTECH PLUS	15.09' / 4.60 m	–	12	18.5 x 8.5-8
Twin rotor rake with centre swath placement				
TOP 612	19.36' / 5.90 m	–	11	16 x 6.5-8
TOP 612 C	19.36' / 5.90 m	–	11	16 x 6.5-8
TOP 702 C	21.16 – 22.47' / 6.45 – 6.85 m	20.51 – 22.64' / 6.25 – 6.90 m	11	16 x 6.5-8
TOP 762 C CLASSIC	21.16' / 6.85 m	–	11	16 x 6.5-8
TOP 762 C	22.64 – 24.28' / 6.90 – 7.40 m	22.15 – 24.60' / 6.75 – 7.50 m	13	16 x 6.5-8
Large twin rotor centre swath rake				
TOP 842 C	25.26 – 27.56' / 7.70 – 8.40 m	25.26 – 27.56' / 7.70 – 8.40 m	13	16 x 6.5-8
TOP 962 C	28.22 – 37.95' / 8.60 – 9.60 m	28.22 – 37.95' / 8.60 – 9.60 m	15	16 x 6.5-8
Twin rotor rake with side swath placement				
TOP 611 A TOPTECH PLUS	11.15 – 20.34' / 3.40 – 6.20 m	11.15 – 20.34' / 3.40 – 6.20 m	12	18.5 x 8.5-8
TOP 691 A TOPTECH PLUS	13.78 – 22.64' / 4.20 – 6.90 m	13.78 – 22.64' / 4.20 – 6.90 m	12	18.5 x 8.5-8
TOP 652	21.0' / 6.40 m	–	10 + 12	16 x 6.5-8
TOP 662	21.49' / 6.55 m	21.49 or 23.95' / 6.55 or 7.30 m	12	16 x 6.5-8
TOP 722	22.31' / 6.80 m	22.31 or 24.93' / 6.80 or 7.60 m	13	16 x 6.5-8
TOP 812	24.93' / 7.60 m	–	13	16 x 6.5-8
Four rotor rake – centre swath				
TOP 1252 C	26.3 – 41.0' / 8.0 – 12.50 m	26.3 – 41.0' / 8.0 – 12.50 m	13	16 x 6.5-8

Tyres	Transport width	Transport length	Transport height	Weight
Transport chassis	(with tine arms)		Parking height	
–	6.40' / 1.95 m (9.19' / 2.80 m)	–	–	1045 lbs / 474 kg
–	6.40' / 1.95 m (9.84' / 3.00 m)	–	–	1179 lbs / 535 kg
–	7.51' / 2.29 m	–	–	1609 lbs / 730 kg
–	7.51' / 2.29 m	–	–	1686 lbs / 765 kg
–	7.74' / 2.36 m	–	–	1653 lbs / 750 kg
–	7.74' / 2.36 m	–	–	1841 lbs / 835 kg
–	8.85' / 2.70 m	10.27' / 3.13 m	11.15 / 8.86' / 3.40 / 2.70 m	2227 lbs / 1010 kg
260/70-15.3	8.37' / 2.55 m	16.90' / 5.15 m	11.55 / 9.58' / 3.52 / 2.92 m	3241 lbs / 1470 kg
260/70-15.3	8.37 or 9.51' / 2.55 or 2.90 m	19.13' / 5.83 m	12.47 / 10.83' / 3.80 / 3.30 m	3407 lbs / 1680 kg
260/70-15.3	8.37 or 9.51' / 2.55 or 2.90 m	19.13' / 5.83 m	13.09 / 11.48' / 3.99 / 3.50 m	3968 lbs / 1800 kg
260/70-15.3	8.37 or 9.51' / 2.55 or 2.90 m	19.13' / 5.83 m	13.09 / 11.48' / 3.99 / 3.50 m	4277 lbs / 1940 kg
340/55-16	9.51' / 2.90 m	21.33' / 6.50 m	13.09 / 11.48' / 3.99 / 3.50 m	5687 lbs / 2580 kg
340/55-16	9.68' / 2.95 m	22.97' / 7.00 m	15.09 / 12.96' / 4.60 / 3.95 m	6900 lbs / 3130 kg
–	6.89' / 2.10 m	23.29' / 7.10 m	–	3726 lbs / 1690 kg
–	7.87' / 2.40 m	25.26' / 7.70 m	–	3814 lbs / 1730 kg
260/70-15.3	9.68' / 2.95 m	25.92' / 7.90 m	13.12 / 11.81' / 4.0 / 3.60 m	4409 lbs / 2000 kg
260/70-15.3	8.37 or 9.51' / 2.55 or 2.90 m	26.57' / 8.10 m	13.09 / 11.81' / 3.99 / 3.60 m	4387 lbs / 1990 kg
340/55-16	8.56 or 9.51' / 2.61 or 2.90 m	29.19' / 8.90 m	13.09 / 11.81' / 3.99 / 3.60 m	5489 lbs / 2490 kg
340/55-16	9.51' / 2.90 m	31.82' / 9.70 m	13.09 / 11.81' / 3.99 / 3.60 m	6195 lbs / 2810 kg
500/50-17	9.84' / 3.00 m	33.63' / 10.25 m	13.09 / 11.15' / 3.99 / 3.40 m	13922 lbs / 6315 kg

Standard & Optional Equipment



Single-rotor rake	Stabiliser struts	MULTITAST jockey wheel 16 x 6.50-8	Tandem axles	Hydraulic swath curtain lifting
TOP 342	<input type="checkbox"/>	<input type="checkbox"/>	<input type="checkbox"/>	<input type="checkbox"/>
TOP 382	<input type="checkbox"/>	<input type="checkbox"/>	<input type="checkbox"/>	<input type="checkbox"/>
TOP 422	<input checked="" type="checkbox"/>	<input type="checkbox"/>	<input checked="" type="checkbox"/>	<input type="checkbox"/>
TOP 462	<input checked="" type="checkbox"/>	<input type="checkbox"/>	<input checked="" type="checkbox"/>	<input type="checkbox"/>
TOP 421 A / 461 A	-	<input type="checkbox"/>	<input checked="" type="checkbox"/>	<input type="checkbox"/>



Twin rotor rakes	Individual lift capability for rotors	Hydraulic working width adjustment	Tandem axles	MULTITAST wheels 16 x 6.50-8
TOP 612	-	-	<input type="checkbox"/>	<input type="checkbox"/>
TOP 612 C	<input type="checkbox"/>	-	<input type="checkbox"/>	<input type="checkbox"/>
TOP 702 C	<input type="checkbox"/>	<input type="checkbox"/>	<input type="checkbox"/>	<input type="checkbox"/>
TOP 762 C CLASSIC	<input type="checkbox"/>	-	<input type="checkbox"/>	<input type="checkbox"/>
TOP 762 C	<input type="checkbox"/>	<input type="checkbox"/>	<input checked="" type="checkbox"/>	<input type="checkbox"/>
TOP 842 C / 962 C	<input type="checkbox"/>	<input checked="" type="checkbox"/>	<input checked="" type="checkbox"/>	<input type="checkbox"/>
TOP 652	-	-	<input checked="" type="checkbox"/>	<input checked="" type="checkbox"/>
TOP 662	<input type="checkbox"/>	<input type="checkbox"/>	<input type="checkbox"/>	<input type="checkbox"/>
TOP 722	<input type="checkbox"/>	<input type="checkbox"/>	<input checked="" type="checkbox"/>	<input type="checkbox"/>
TOP 812	<input type="checkbox"/>	<input checked="" type="checkbox"/>	<input checked="" type="checkbox"/>	<input type="checkbox"/>
TOP 611 A / 691 A	-	<input checked="" type="checkbox"/>	<input checked="" type="checkbox"/>	<input type="checkbox"/>

■ = Standard, □ = Option

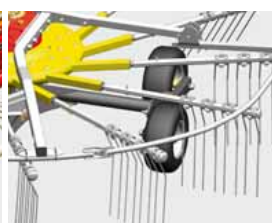



More equipment options:

Spare wheel 15 x 6.0-6

Tine covers for twin rotor rake

Wide-angle PTO shaft for TOP 421 A / 461 A TOPTECH PLUS, TOP 612 C / TOP 702 C / 762 C

Steered narrow chassis for twin rotor rakes

Flow splitter for twin rotor rakes

Warning triangle for twin rotor rakes

Air brakes or hydraulic brakes for TOP 962 C

TOP 611 A / 691 A TOPTECH PLUS

Parallel lifting drawbar

Hydraulic swath curtain lifting

Swath curtain	Tyres 340/55-16	Tyres 380/55-17	Tyres 15/55-17 AS
<input type="checkbox"/>	-	-	-
<input type="checkbox"/>	<input type="checkbox"/>	-	<input type="checkbox"/>
<input type="checkbox"/>	<input type="checkbox"/>	<input type="checkbox"/>	<input type="checkbox"/>
<input type="checkbox"/>	<input type="checkbox"/>	<input type="checkbox"/>	<input type="checkbox"/>
<input type="checkbox"/>	<input type="checkbox"/>	<input type="checkbox"/>	<input type="checkbox"/>
<input type="checkbox"/>	<input checked="" type="checkbox"/>	<input type="checkbox"/>	<input type="checkbox"/>
<input checked="" type="checkbox"/>	<input type="checkbox"/>	-	-
<input checked="" type="checkbox"/>	<input type="checkbox"/>	<input type="checkbox"/>	<input type="checkbox"/>
<input checked="" type="checkbox"/>	<input checked="" type="checkbox"/>	<input type="checkbox"/>	<input type="checkbox"/>
<input checked="" type="checkbox"/>	<input checked="" type="checkbox"/>	<input type="checkbox"/>	<input type="checkbox"/>
<input checked="" type="checkbox"/> second rotor	-	-	-





Four rotor rake

POWER CONTROL

**ISOBUS
CCI 100**

Jockey wheels MULTITAST

Hydraulic height adjustment

TOP 1252 C

■ = Standard, □ = Option



Floodlights LED

More equipment options:

Load-sensing

Tyres 620/40 R 22.5

Tyres 710/35 R 22,5

Hydraulic brakes in lieu of air brakes

Spare wheel 15 x 6.0-6



PÖTPRO

Your machine goes online.

All the information on your machine
easily – anytime – anywhere

Simply scan the QR code on the **data plate** with your smartphone or tablet or enter your machine number at www.poettinger.at/poetpro. You will immediately receive all the information on your machine.

- Instruction manuals
- Optional equipment information
- Brochures
- Photos and videos



PÖTTINGER Original Parts

PÖTTINGER Spare parts service

- Worldwide network of sales and service partners.
- Decades of spare and wear parts availability.
- Original PÖTTINGER parts can be ordered online around the clock.

PÖTTINGER Landtechnik GmbH

Industriegelände 1
4710 Grieskirchen
Austria
Phone +43 7248 600-0
Fax +43 7248 600-2513
info@poettinger.at
www.poettinger.at

Alois PÖTTINGER UK Ltd.

15 St Marks Road, Corby
Northamptonshire,
NN18 8AN
United Kingdom
Phone + 44 1536 272 220
info.uk@pottingeruk.co.uk
www.pottingeruk.co.uk

PÖTTINGER Canada Inc.

650, Route 112
St-Cesaire, PQ J0L 1T0
Canada
Phone +1 450 469 5594
Fax +1 866 417 1683
sales.canada@poettinger.ca
www.poettinger.ca

PÖTTINGER US, Inc.

393 Pilot Drive
Valparaiso, IN 46383
USA
Phone +1 219 510-5534
Fax + 1 219 707-5412
sales.us@poettinger.us
www.poettinger.us

PÖTTINGER Australia PTY LTD

15 Fordson Road
Campbellfield, VIC 3061
Australia
Phone +61 3 9359 2969
sales.au@poettinger.com.au
www.poettinger.com.au

PÖTTINGER Ireland Ltd.

Industrial Estate
Cashel Rd., Clonmel, Co. Tipperary
Ireland
Phone +353 52 6125766
info.ie@poettinger.at
www.poettinger.ie

Importer for New Zealand:

Origin Agroup
PO Box 673, 57 Hautapu Road
Cambridge
New Zealand
Phone +64 7 823 7582
info@originagroup.co.nz
www.originagroup.co.nz

Importer for South Africa:

VALTRAC
Cnr. Water & Buiten Street
9585 Parys
South Africa
Phone +27 56 817 7338 7308
wynn@valtrac.co.za
www.valtrac.co.za

