

NOVADISC / NOVACAT
front, rear and
trailed disc mowers

 **PÖTTINGER**

First class cut.





First class cut for the sake of your livestock.



NOVADISC / NOVACAT front, rear and trailed disc mowers

A precision mowing process is the starting point for high forage quality. Farmers expect the best possible ground tracking, minimal disintegration losses and precision mowing without wasting any time in the field. Our front and rear mounted disc mowers minimise forage contamination thanks to their excellent ground tracking and balance. Something your livestock will appreciate.

Contents

	The best forage	4-5
	PÖTTINGER cutter bars	6-11
	Neat conditioning	12-13
	Front mowers	14-21
	NOVACAT CLASSIC front mowers	16-17
	NOVACAT ALPHA MOTION PRO / NOVACAT ALPHA MOTION MASTER front mowers	18-21
	Rear mowers	22-33
	NOVADISC rear mowers with side pivot mounting	24-25
	NOVACAT rear mowers with centre pivot mounting	26-29
	CROSS FLOW swath merging with cross flow auger	30-33
	Trailed mowers	34-39
	NOVACAT T trailed mowers	36-37
	COLLECTOR swath merging with cross conveyor belt	38-39
	Accessories / Technical data	40-47
	Accessories	40-41
	Technical data	42-45
	PÖTPRO / ORIGINAL PARTS	46-47

All information on technical data, dimensions, weights, output, etc. and the images shown, are approximate and are not binding. The machines shown do not feature country-specific equipment and may include equipment that is not supplied as standard, or is not available in all regions. Your PÖTTINGER dealership would be pleased to provide you with more information.

The best forage



The best forage quality is the basis for your success

High yielding dairy cattle need high quality base forage with the optimum structure. This is readily consumed by the animals in sufficient quantities. That is the best way to prepare the rumen to process the forage as productively as possible. Improving base forage quality reduces dependence on concentrates and promotes animal health; both of which lower your costs. Healthy cattle express their gratitude with better fertility, by producing milk for longer, and even more decisively with higher milk yields. The bottom line is that you benefit from clean, high quality forage with more profits from your dairy business.

NOVADISC / NOVACAT front, rear and trailed disc mowers



Intelligent soil conservation

The foundation stone for harvesting high quality forage is laid during the mowing process. The more precisely the mowers glide over the ground, the cleaner your forage remains. Our disc mowers represent the best in ground tracking. After all, the "floating cut" was developed by PÖTTINGER back in the 80s. Optimum weight alleviation of the mower units is our top priority. Centre pivot mounting with maximum ground tracking, powerful suspension springs or hydraulic cylinders and intelligent kinematics help you harvest quality forage.

Clean forage, cut after cut.

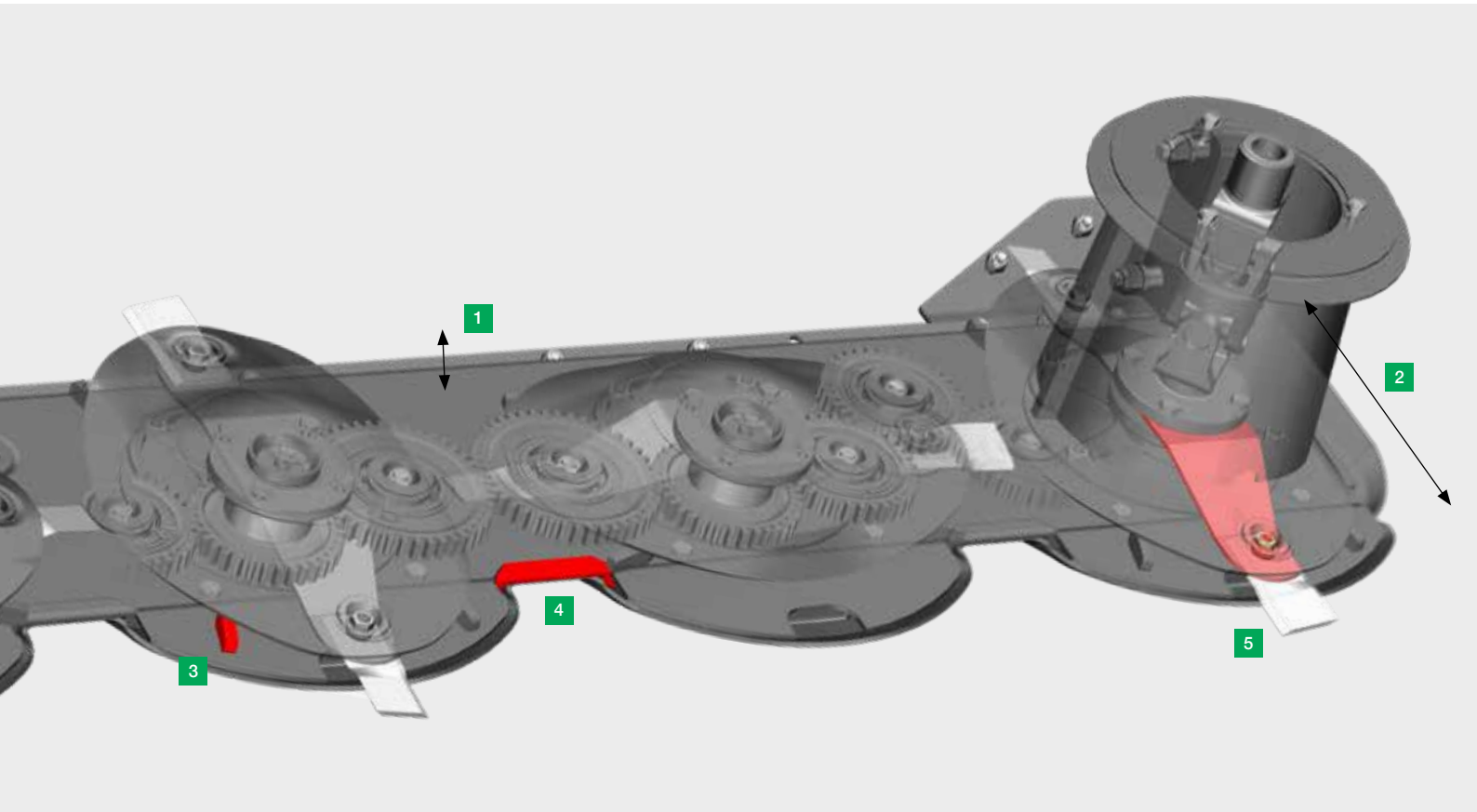

PÖTTINGER cutter bars - quality made in Austria

At the heart of PÖTTINGER disc mowers is the cutter bar, proven over thousands of cuts in the field. NOVACAT disc mower cutter bars are developed and built at the company's main plant in Grieskirchen - a quality product made in Austria. First-class cutting quality, low drag resistance and strength are the trademarks of these cutter bars.

PÖTTINGER cutter bars

- 1** Cutter bar height only 4 cm
- 2** Cutter bar width only 28 cm
- 3** Integrated cleaning paddles
- 4** Clamped counter knife
- 5** Clamped blades

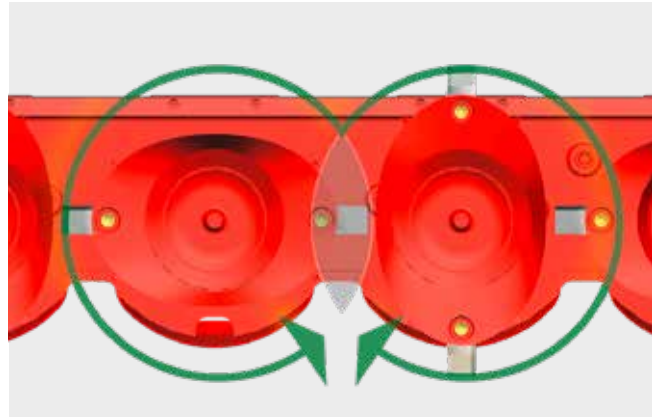

Optimum crop flow – clean forage

- The extremely flat cutter bar is only 4 cm high and 28 cm wide - the ideal geometry for the best ground tracking. **(1)** and **(2)**
- Integrated paddles keep the cutter bar surface clean. **(3)**
- The counter knife is clamped in place, so it is easy to replace. **(4)**
- The clamped quick change mower blades rotate very close to the surface of the cutter bar and the counter knife. The optimised overlap of blade paths ensures a clean and uniform mowing pattern. **(5)**

Durable



For a long life

So that you can keep mowing trouble-free, we build your mower to be extremely hard wearing and resilient. Engineered details guarantee you reliable operation and contribute significantly to an extended service life.

TRI DRIVE

The spur gear drive runs in a straight line with virtually the same sized gears. On the gears there are always three teeth in contact with each other – this ensures optimum power transmission. Moreover, there is less stress on the individual gears in the event of stone impact. The specially ground surface of the gears submerged in gear oil ensures smooth running. This reduces the noise level considerably.

- Gear set 39/50
- Gear height 17.5 mm

Hardened steel blades

Long, tough jobs demand the best quality blades. That is why Original PÖTTINGER blades are made using high quality knife steel.

PÖTTINGER cutter bars



Practical modular design

The bearing flange and fittings are reliably protected by rubber o-ring seals. The gears and bearings can be removed as one unit, while the idler gears are easily removed through the openings - it could not be more straightforward.



High-strength stub shafts

The stable stub shafts are bolted to the gears and are thus easy to replace when required.

Heavy-duty bearings

Durable, twin race taper bearings with a bearing spacing of 60 mm are extremely stress-resistant.

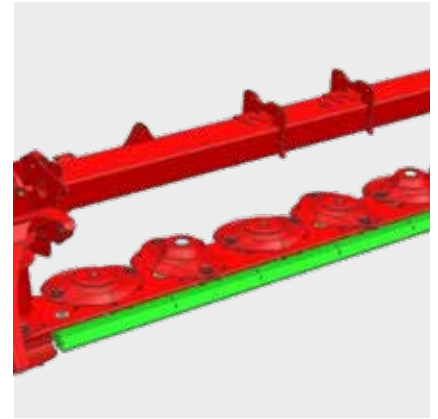

HEAVY DUTY cutter bars

An additional cutter bar reinforcement is offered as an option for especially stony areas (Standard on NOVACAT 402 / 442).

Convenience and equipment



Easy to maintain, when it matters

Maintenance is important. And of course you want to be fully operational again quickly. Our mowers are service-friendly and save you valuable time during maintenance.

Quick-change knife

All you have to do is press down the spring clip with the blade wrench and replace the blade. The blade is locked securely in place by the spring clip.

The blade pin is bolted to the mower disc. This can be replaced cost-effectively if required.

A handy blade box provides space for replacement blades.

PÖTTINGER cutter bars



Best accessibility

We take ease of maintenance seriously. The guards fold well away to provide optimum access to the cutter bar. Now you can change blades quickly and easily. For even more convenience, the side guards can also be raised hydraulically if required.



Wear resistant skids

Wide skids made from hardened boron steel to resist impact and prevent the build-up of soil. Because the underside of the cutter bar is smooth with contoured skids inside and outside, it protects the sward even when cornering.

As an option, you can fit additional wear skids to protect the underside of the cutter bar. The bolted skids can be easily changed if required.

Optional high cut skids can be mounted to increase the cutting height from 50 to 120 mm. Their large radius and wide surface area make them especially wear resistant.

- High cut skid + 20 mm, the universal skid especially for stony soil.
- High cut skid + 40 mm, especially for whole crop.
- High cut skids also for both outer skids.



Optional feed cones

The aggressive shape of the feed cone keeps the crop flowing. In addition, swath doors can be fitted.

Neat conditioning



Why use a conditioner?

In order to keep the energy content of the crop as high as possible, fast and gentle drying is required. When mowing with conditioner, you save one thing above all else: time. The tines or rollers integrated into the mower fold or crimp the crop and place a wide and loose forage carpet - the best prerequisites for a fast drying process. When mowing with a conditioner you save an entire pass - that is pure cost effectiveness. The level of dryness required is achieved sooner, allowing you to use fair weather days more efficiently and thus significantly reduce your weather risk. By eliminating the tedding process, you also reduce disintegration losses.

EXTRA DRY (ED) / ROLLER CONDITIONER BELT (RCB)



Rapid and uniform drying: ED tine conditioner

The EXTRA DRY conditioner is a joint development with the Institute of Agricultural Engineering (IMAG-DLO) in Wageningen (Holland) that started in 1997 to prove there is a better way.

V-shaped tines made of hardened steel hit the stalks in the crop and guarantee a continuous flow of forage. The tines are mounted flexibly on rubber blocks. The round, high volume conditioner hood and the adjustable guide vanes enable a loose and airy blanket to be placed. You can adjust the conditioning intensity.

Depending on individual requirements, a wide spread blanket or swath formation is possible.

Available for:

NOVACAT 261 / 301 / 351 ALPHA MOTION PRO.
NOVACAT 262 / 302 / 352.
NOVACAT 307 T / 3007 T / 3507 T.

Careful and effective: RCB roller conditioner

The RCB roller conditioner is especially suitable for alfalfa and clovers due to its precision conditioning capabilities. The rollers inter-mesh to uniformly crimp the stalks and produce a uniform blanket of forage. You can adjust the roller spacing and conditioner pressure flexibly. Both rollers are driven for maximum output. The toothed belt drive system is low maintenance and protected against dirt ingress.

Available for:

NOVACAT 261 / 301 / 351 ALPHA MOTION PRO.
NOVACAT 262 / 302 / 352.
NOVACAT 307 T / 3007 T / 3507 T.

Front mounted mowers





Not only an eye-catcher for its looks

Our PÖTTINGER front mowers impress first and foremost with their perfect ground tracking. With their intelligent technology, they glide perfectly over every undulation in the ground. The result: Your forage remains clean.

Plus, you always look great at work thanks to the modern design of your kit. That is the real joy of mowing.

Cost effective mowing



NOVACAT CLASSIC



The lightweight

With the NOVACAT CLASSIC front mower you can mow easily and cost effectively. Thanks to its lightweight construction and short headstock, this can be used with smaller tractors. You saves you fuel as a result.



Perfect ground tracking

The trademark of this front mower is the headstock. The sophisticated linkage geometry brings the centre of gravity as close to the tractor as possible in all working positions. Gimbals on the cutter bar guide arms guarantee smooth freedom of movement. With a travel of +/- 8 degrees, the mower is guided accurately over each bump in the ground.

Tailored to your needs

Two outer disc pairs rotate inwards. The individually adjustable swathing discs place the forage in a swath of the desired width. Additional swathing discs are available for an even narrower swath placement.

Change fields without leaving the cab

The side guards are strong full-length pressed steel parts. Hydraulic folding is available if required. That makes things more convenient for you.

Unique ground tracking



NOVACAT ALPHA MOTION MASTER: -7° / $+13^{\circ}$

NOVACAT ALPHA MOTION PRO: -9° / $+12^{\circ}$

Simply tidy mowing

The best adaptation to every bump in the ground is the prerequisite for a neat mowing pattern. Our ALPHA MOTION front mowers meet all requirements. Smaller fields with bumps or large areas where you want to accelerate: you will always leave a neatly mown crop behind you, laying the foundation for quality forage.

Unique ground tracking: ALPHA MOTION

ALPHA MOTION trailed front technology is characterised by the sophisticated kinematics of the active support frame. Compared to other mounting systems, not only do the guide arms respond to every undulation of the terrain, but also the mounting frame itself. As a result, the cutter bar inclines upwards over bumps and slants downwards into dips. The result: Clean forage. You benefit from a consistent cutting height, which leads to uniform growth and ultimately to higher yield for you.

The ultimate headstock

Two large suspension springs are integrated into the headstock. These react quickly to any bump in the ground, which means that weight alleviation remains the same over the mower's entire working distance. This ensures uniform pressure on the ground - and protects your soil in the best possible way.

You can hitch up these mowers to any tractor starting at 55 hp, regardless of tractor make and type. The centre of gravity is close to the tractor in all working positions. You mow smoother as a result.



Your advantages with ALPHA MOTION

- The active supporting frame and link rods guide the cutter bar over every undulation in the ground: The cutter bar rises to float over each bump and glides down into each dip.
- The mower moves virtually on a vertical plane, minimising telescoping of the PTO shaft and greatly reducing dynamic stress.
- Unique freedom of transverse movement +/- 16° thanks to gimbals on the linkage arms.
- Two powerful highly responsive springs in the headstock: Perfectly balanced weight alleviation over the whole working width. The mower can be driven at high speed without the cutter bar rising.
- A huge ground clearance of 350 mm is provided at headlands and in the transport position. You can drive over swaths without damaging them and transport the mower on bumpy tracks.
- Perfect view of the work area from the tractor seat thanks to sleek design of the headstock.

The right equipment options to match every specification



NOVACAT ALPHA MOTION PRO / MASTER



Even smoother mowing: ALPHA MOTION MASTER

The NOVACAT ALPHA MOTION MASTER front mower has a shortened three-point headstock and is 34 cm closer to the tractor. Because more weight acts on the rear axle of the tractor, you get even better driving performance. The power requirement is lower, which is why lighter tractors can also be used. This helps you save fuel. In addition, the new mower is lighter.

A conditioner is not available on this model.

New: ALPHA MOTION PRO

Proven ALPHA MOTION front mower technology is now even easier to use.

The new NOVACAT ALPHA MOTION PRO front mower features a new design, delivers the first-class ground tracking you expect from our machinery, and makes your working day a great deal easier:

- The three-point linkage ensures easy attachment to any size of tractor.
- The folding front guard provides the best access to the cutter bar for cleaning and changing blades.
- It is easy to release of the cover for convenient adjustment of the suspension springs.
- A central greasing point on the headstock makes servicing easier.

You can use the ALPHA MOTION PRO models without conditioner with swath doors or in combination with an ED tine conditioner or RCB roller conditioner.

As an option, the side guards can be folded hydraulically conveniently from the tractor seat.

Using an optional hydraulic hose and sensor package, ALPHA MOTION front mowers can be conveniently operated using the electronic control terminal for NOVACAT mower combinations.

Rear mounted mowers





Neat work from behind

The NOVADISC rear mowers with side pivot mounting are our lightweight models that run smoothly and easily. Thanks to their low weight, these mowers are also suitable for use on steep ground.

Our NOVACAT rear mowers with centre pivot mounting feature optimum weight alleviation and float over any unevenness in the ground.

Rear mounted mowers with side pivot mounting



Cost-effective and suitable for working on slopes

The new generation of NOVADISC rear mowers with side pivot mounting are the lightweights in their class.

Lightweight construction with high rigidity

Thanks to their comparatively low weight, these mowers can be operated with smaller tractors starting from 40 hp. This means you save fuel and mow smoothly.

Able to adapt

The wide + 22/- 30 degree arc of movement enables easy mowing on rough ground and embankments. For a short-time mowing up to + 45° through lifting the interlocking lid is permitted.



Safe and practical

The optimised centre of gravity of the machine ensures safe and compact road transport. In the transport position, the mower is folded through 102°. This gives you a clear view to the rear through both rear-view mirrors. Using the optional hydraulic folding side guard, you can achieve the lowest possible transport height.

With the optional parking stand, your mower can be parked vertically to save space.

Modern design

The new NOVADISC series brings you modern PÖTTINGER design with an eye-catching design to match its performance.

Easily mounted

- Thanks to the adjustable mounting pins, these mowers can be hitched up to your tractor quickly and easily.
- Two headstocks are available for outer track widths of 1800 – 2200 mm and 2200 – 2600 mm.
- Practical PTO shaft holder makes hitching up easier.

NOVADISC 222 / 262 / 302 / 352



Unique suspension system

Two suspension springs guarantee the cutter bar applies hardly any pressure to the ground. Weight alleviation is adjustable in three stages without the need for tools. The unique kinematics ensure that the cutter bar applies the same pressure to the ground over the entire width. The ground pressure can be adapted flexibly to individual operating conditions. This enables you to keep wear and power requirements as low as possible.

NOVADISC lifting system

The mower is lowered so that the outer end of the cutter bar contacts the ground first. At the headland, the inside end is lifted first. That is how your sward is perfectly protected.

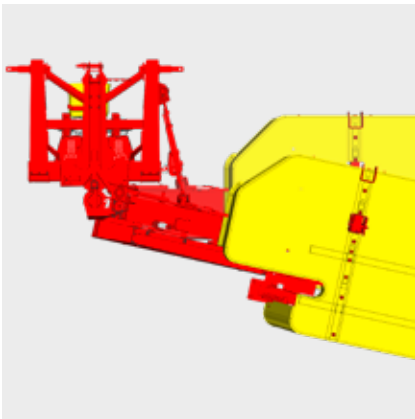

Protected against damage

The mechanical collision safety device provides a swing arc of approx. 12°. This prevents you from damaging the mower in the event of a collision. After it has been triggered, simply reverse the machine a short distance to engage the cutter bar again.



Long service life

Mounting points at each end of the cutter bar protect it against twisting. As a result, the gears and bearings are subjected to less stress to guarantee smooth operation and a long service life.

The compact driveline and drive belt tension regulated by a back tension idler ensure robust and reliable power transmission.

Convenience

The guards fold away to provide optimum access to the cutter bar. This makes it possible to clean the machine thoroughly and change blades quickly and easily. The guard curtains are made from especially tough material to reliably catch stones and soil.



Rear mounted mowers with centre pivot mounting



Centre pivot mounting for optimised ground tracking

Since the mid-80s, our mower developments have focussed on the "floating cut".

The NOVACAT centre pivot mounting supports the cutter bar evenly over the entire cutting width. Your mower floats over any ground contour. The mowed crop remains clean and you also save fuel thanks to the reduced power requirement. Due to the uniform cutting height, you benefit from optimum growth and ultimately from higher yields.

Our NOVACAT rear mowers can be equipped with swathing discs or a conditioner to meet your individual requirements.



Hitching up made easy

Short harvest windows require a rapid response. With our rear mowers, you don't lose any time when it counts.

Variable mounting

Thanks to the adjustable mounting pins, these mowers can be hitched up to a wide range of tractor types quickly and easily. As a result you make full use of the whole mowing width. Practical PTO shaft holder makes hitching up easier.

Hydraulic lower linkage arm

The hydraulic lower linkage arm makes it easy for you to hitch up without having to adjust the linkage struts on the tractor. You also benefit from the right weight alleviation and optimum ground clearance at the headland.



Smooth running

The advantage of our rear mowers is their smooth operation. The friction-locked drive train is stress-free via cardan shafts and a gearbox directly through to the first mower disc.



Superior handling over obstacles and bumps

To protect your machine, the cutter bar can fold right back if it collides with obstacles. The triggering force is adjustable. A hydraulic collision safety device is also available as an option.

Hydraulic weight alleviation provides uniform ground pressure over the whole cutter bar width. The pressure of the cutter bar on the ground can be infinitely-variable adjusted depending on the condition of the ground and the conditioner or swath formers fitted.

You can rely on the floating cut



A more relaxed way to finish the job

NOVACAT 262 / 302 / 352 V rear mowers take the worry out of it. Before you start you benefit from effortless attachment, while work is in progress the perfect ground tracking ensures that you enjoy mowing and after the job is finished, you can bring your mower home safely.

50 cm ground clearance

With the generous clearance height of 50 cm, you not only pass over bumps without risk, but also do not damage any swaths when driving over them. Your forage will be well protected.

The wide +/- 22.5° arc of movement enables easy mowing on rough ground and embankments.



Vertical transport position (NOVACAT 262 / 302 / 352 V)

A practical transport position is achieved by raising the mower through 115°. This keeps the transport height as low as possible. The view to the rear is unrestricted via both exterior mirrors. The optimum distribution of the centre of gravity ensures a pleasant drive. The cutter bar is raised using double-acting spool valves.



NOVACAT 262 / 302 / 352 V / 352 / 402 / 442



High output rear mowers

The top end of our rear-mounted mower range without conditioners is represented by the NOVACAT 402 and 442 with working widths of 3.88 m and 4.30 m.

Paddle and feed drums

Paddle drums at both ends of the cutter bar on the NOVACAT 402 / 442 place a neat swath leaving a tidy wheel track clear. The swath can be divided with two feed drums (optional). The tractor can then drive along a cleared track instead of along the edge of the swath.



Maximum ground clearance

At the headland, ground clearance is up to 50 cm. During lifting, the cutter bar is held firmly in place by a stabiliser cylinder. This makes it easier to drive over swaths and optionally offers greater stability during transport.

Horizontal transport position (NOVACAT 352 / 402 / 442)

A narrow and low transport position is possible by folding the mowers backwards hydraulically. Now you can keep an eye on everything behind you during transport. The folding mechanism also doubles as a collision safety device.



The auger does the trick



Swath merging without a conditioner

CROSS FLOW is a cost effective system for merging swaths. A cross flow auger is integrated in the mower unit to deposit the forage in the way you want it to be: Either merged as a swath or spread over the working width of the rear mower.

Best forage

Dispensing with the conditioner means that your forage is handled with minimum impact.

Thanks to the closed trough shape, the forage is transported directly from the sward to the swath. Dirt ingress is reduced to a minimum.

In addition, disintegration losses are avoided. This provides optimum conditions for the best possible processing of plants that are rich in energy.

You can use the CROSS FLOW system in a variety of ways, both in grassland and for whole plant silage.

NOVACAT 302 / 352 CROSS FLOW (CF)



Cost effectiveness

CROSS FLOW works without a conditioner and is characterised by its light tare weight compared to conventional swath merging systems. This not only conserves the soil, but also saves fuel: In comparison to the cross conveyor belt system, with CROSS FLOW 20% less power is required.

Maximum output

The auger is installed in the mower at a slight angle. This ensures optimum throughput. Even large volume crops and whole plant silage are placed in a tidy swath at a high output.

Scraper bars on the rear panel of the auger ensure blockage-free operation with a wide variety of forage conditions.

Hydraulic rear panel opening

For even more convenience, the rear panel can be opened hydraulically from the comfort of the tractor seat. This makes the system ideal for flexible applications.

New: CROSS FLOW as a 3 m version

The CROSS FLOW system is now available not only on the 3.50 m version (NOVACAT 352 CROSS FLOW) but also on the 3 m version as the NOVACAT 302 CROSS FLOW. This is unique on the market.

NOVACAT 302 CROSS FLOW for tractors starting from 100 hp

You can operate this narrower machine with tractors starting at 100 hp. It doesn't get more cost effective than this. In addition to the proven advantages of the CROSS FLOW system, you also benefit from the cost saving due to lower fuel consumption.

One machine, many applications



Enjoy maximum flexibility

The CROSS FLOW system is versatile in the range of applications that it offers to make your working day in the field a great deal easier.

Quicker drying

This innovative solution still provides a conditioning effect, however, because the cross flow auger turns the flow of forage to accelerate the drying of the mown crop.



Intelligent mowing

When mowing along the field boundary, the cross flow auger can transport the crop to the inside. This is done with the rear flap closed. This ensures that your forage remains inside the field boundary during the subsequent tedding process.

Single swath placement, direct pick-up

The swath is placed so that you can pick up and transport your forage away directly after mowing. This means that on hot summer days, for example, you can ensure that the crop does not dry too fast before you can harvest it.



NOVACAT 302 / 352 CROSS FLOW (CF)

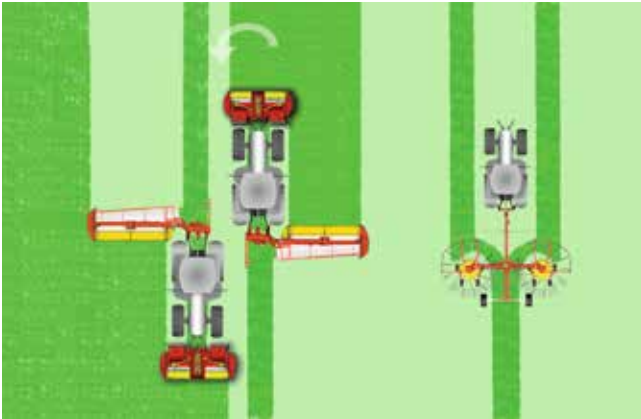

Mow whole plant crops

When the rear flap is closed, the cross flow auger transports the crop to the centre of the swath of the front mower - a loose and even swath is placed.

In combination with a 3 metre front mower, you can mow a width of 12 metres in two lanes, but place the two swaths within approx. 6 metres. One twin rotor centre-swath rake is then sufficient on the next pass. In this way you can significantly reduce the number of passes and conserve the soil as well as your forage. You also save valuable time and fuel.



Single-side wide placement

For a more intensive drying effect, open the rear flap to place a wider and airier blanket of forage.



Trailed mowers



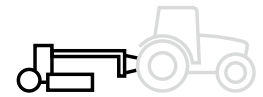

For the perfect cut

The PÖTTINGER trailed disc mowers mow perfectly on all surfaces, even in uneven and undulating ground conditions. You are sure to get three-dimensional ground tracking thanks to the freedom of movement enabled by the cutter bar being suspended in the portal frame. This guarantees you the best forage in any terrain.



Clean forage wherever you go



High performance with small tractors

On the trailed version with chassis, you do not need any lifting power, so you can also use lower power tractors. This helps you save fuel.

The NOVACAT 307 T trailed disc mower features a side drawbar. This is folded hydraulically and the integrated check valve ensure it locks in place



Mow on either side

NOVACAT 3007 T and NOVACAT 3507 T offer you maximum flexibility. The central drawbar, which can be swivelled hydraulically to both sides, enables you to mow on either side. Your mower will ideally adapt to your individual preferences and site conditions.

Crosses swaths without dragging its feet

When driving over mowed crop, you need a lifting system that is convenient to use and provides a generous lifting height.

A special lifting system provides plenty of clearance for driving over large swaths without damaging them. 480 mm of clearance with standard 340/55-16 tyres or 550 mm with the optional grooved profile 11.5/80-15.3 tyres.

Uniform lifting/lowering is enabled by feeding oil from one half of the hydraulic cylinder to the cylinder on the other side.



NOVACAT 307 T / 3007 T / 3507 T



3D ground tracking

The cutter bar adapts to any ground contour so that you float cleanly over the sward. Two large dimensioned, easily-adjustable suspension springs guarantee optimum ground pressure in all conditions. Suspending the mower unit from a portal frame gives the cutter bar a great deal of freedom of movement. The cutter bar is lowered with the portal frame, releasing the cutter bar for perfect ground tracking.



Intelligent cutter bar suspension

Three-dimensional ground tracking is ensured by the freedom of movement enabled by the cutter bar being suspended in the portal frame.

The low-slung cantilever system lets the cutter bar glide over bumps and ridges. The guide arms are mounted on freely-moving ball joints. The guide bars sloping up to the cutter bar provide excellent adaptation to ground contours. A top link guides the top of the mower unit to complete the four-point suspension system.

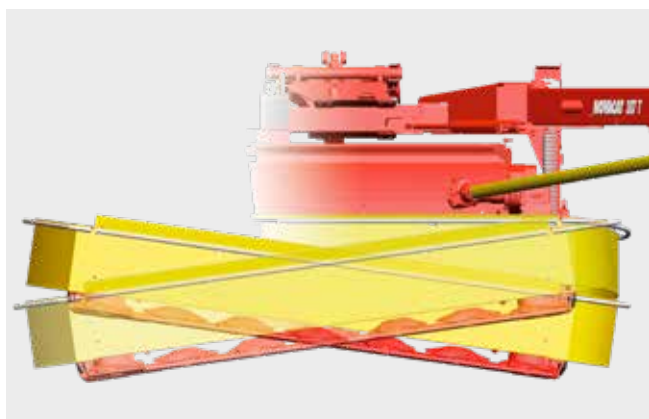

Freedom of vertical movement

- Up to 200 mm upwards, the cutter bar is inclined 5° upwards.
- Up to 120 mm downwards, the cutter bar is angled 3° downwards.

Linkage yoke

The U-shaped linkage yoke provides a free angle of movement of $\pm 30^\circ$. The tractor and mower can then compensate for uneven ground independently of each other.

Cleanly merged, neatly placed



COLLECTOR



Versatile and well proven

With the COLLECTOR you can mow, condition and swath in just one pass. You save time, money and reduce your weather risk. This proven swath merging system is suitable for everyone who does not want to dispense with a conditioner. The COLLECTOR is available together with the ED tine-type conditioner for rapid yet careful drying, or with the RCB roller conditioner, designed especially for leafy forage.



Reliability

Even with large volumes of forage, your mower works reliably thanks to the large conditioner hood and the wide belt. You are guaranteed neat swath placement at maximum output.

Flexible placement

When placing the crop, you can choose between a swath or wide blanket. You can adjust this conveniently from the tractor seat using the hydraulically swivelling cross conveyor belt. Narrower swath placement for loader wagons is also possible by using an accelerator roller.

Operating convenience due to optional control panel

Adjust the belt speed conveniently using the optional control terminal.

The belt switches off automatically when it is folded upwards.

Accessories



NOVACAT front-mounted mowers

	Swathing discs inner / outer	Additional swathing discs	Feed cone	Feed drums to form 2 individual swaths
261 / 301 CLASSIC	■	□	□	□
351 CLASSIC	■	□	□	□
261 ALPHA MOTION MASTER / PRO	■	□	□	-
261 ALPHA MOTION PRO ED / RCB	-	-	□	-
301 ALPHA MOTION MASTER / PRO	■	□	□	-
301 ALPHA MOTION PRO ED / RCB	-	-	□	-
351 ALPHA MOTION MASTER / PRO	■	□	□	-
351 ALPHA MOTION PRO ED / RCB	-	-	□	-

NOVACAT rear mowers with centre pivot mounting

262	□	□	□	-
262 ED / RCB	-	-	□	-
302	□	□	□	-
302 CF	-	-	■	-
302 ED / RCB	-	-	□	-
352 V	□	□	□	-
352	□	□	□	-
352 ED / RCB	-	-	□	-
352 CF	-	-	■	-
402 / 442	□	□	□	□

NOVADISC rear mowers with side pivot mounting

222	□	-	□	-
262 / 302 / 352	□	□	□	-

NOVACAT T trailed mowers

307 T ED	-	-	-	-
307 T RCB	-	-	-	-
307 T ED / RCB COLLECTOR	-	-	-	-
3007 T ED	-	-	-	-
3007 T RCB	-	-	-	-
3007 T RCB COLLECTOR	-	-	-	-
3507 T ED	-	-	-	-
3507 T RCB	-	-	-	-
3507 T ED / RCB COLLECTOR	-	-	-	-

■ = Standard, □ = Optional

Often ordered together.

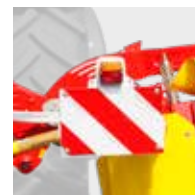
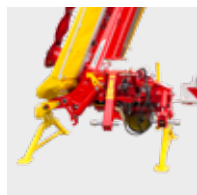

Wear skids

High cut skids +20 mm / +40 mm

Parking stands

Hydraulic folding side guard

Conditioner chassis with quick-change pins

Warning signs and lighting pins

<input type="checkbox"/>	<input type="checkbox"/>	-	<input type="checkbox"/>	-	<input type="checkbox"/>
<input type="checkbox"/>	<input type="checkbox"/>	-	<input type="checkbox"/>	-	■
<input type="checkbox"/>	<input type="checkbox"/>	-	<input type="checkbox"/>	-	<input type="checkbox"/>
<input type="checkbox"/>	<input type="checkbox"/>	-	<input type="checkbox"/>	<input type="checkbox"/>	<input type="checkbox"/>
<input type="checkbox"/>	<input type="checkbox"/>	-	<input type="checkbox"/>	-	<input type="checkbox"/>
<input type="checkbox"/>	<input type="checkbox"/>	-	<input type="checkbox"/>	<input type="checkbox"/>	<input type="checkbox"/>
<input type="checkbox"/>	<input type="checkbox"/>	-	<input type="checkbox"/>	-	■
<input type="checkbox"/>	<input type="checkbox"/>	-	<input type="checkbox"/>	<input type="checkbox"/>	■
<hr/>					
<input type="checkbox"/>	<input type="checkbox"/>	<input type="checkbox"/>	<input type="checkbox"/>	-	■
<input type="checkbox"/>	<input type="checkbox"/>	<input type="checkbox"/>	<input type="checkbox"/>	<input type="checkbox"/>	■
<input type="checkbox"/>	<input type="checkbox"/>	<input type="checkbox"/>	<input type="checkbox"/>	-	■
-	■/□	-	-	-	■
<input type="checkbox"/>	<input type="checkbox"/>	<input type="checkbox"/>	<input type="checkbox"/>	<input type="checkbox"/>	■
<input type="checkbox"/>	<input type="checkbox"/>	<input type="checkbox"/>	<input type="checkbox"/>	-	■
<input type="checkbox"/>	<input type="checkbox"/>	-	-	-	■
<input type="checkbox"/>	<input type="checkbox"/>	-	-	<input type="checkbox"/>	■
-	■/□	-	-	-	■
<input type="checkbox"/>	<input type="checkbox"/>	-	-	-	■
<hr/>					
<input type="checkbox"/>	<input type="checkbox"/>	<input type="checkbox"/>	<input type="checkbox"/>	-	<input type="checkbox"/>
<input type="checkbox"/>	<input type="checkbox"/>	<input type="checkbox"/>	<input type="checkbox"/>	-	<input type="checkbox"/>
<hr/>					
<input type="checkbox"/>	<input type="checkbox"/>	-	-	-	■
<input type="checkbox"/>	<input type="checkbox"/>	-	-	-	■
<input type="checkbox"/>	<input type="checkbox"/>	-	-	-	■
<input type="checkbox"/>	<input type="checkbox"/>	-	-	-	■
<input type="checkbox"/>	<input type="checkbox"/>	-	-	-	■
<input type="checkbox"/>	<input type="checkbox"/>	-	-	-	■
<input type="checkbox"/>	<input type="checkbox"/>	-	-	-	■
<input type="checkbox"/>	<input type="checkbox"/>	-	-	-	■
<input type="checkbox"/>	<input type="checkbox"/>	-	-	-	■

Technical data

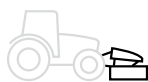

NOVACAT front-mounted mowers	Working width	Mounting	Tractor PTO speed	Hectares per hour up to acres/h / ha/h
NOVACAT 261 CLASSIC	2.62 m	A-frame mounting	1000 rpm	2.60
NOVACAT 301 CLASSIC	3.04 m	A-frame mounting	1000 rpm	3.00
NOVACAT 351 CLASSIC	3.46 m	A-frame mounting	1000 rpm	3.40
NOVACAT 261 ALPHA MOTION MASTER	2.62 m	Cat. 2 / Width 2	1000 rpm	2.60
NOVACAT 261 ALPHA MOTION PRO	2.62 m	Cat. 2 / Width 2	1000 rpm	2.60
NOVACAT 261 ALPHA MOTION PRO ED	2.62 m	Cat. 2 / Width 2	1000 rpm	2.60
NOVACAT 261 ALPHA MOTION PRO RCB	2.62 m	Cat. 2 / Width 2	1000 rpm	2.60
NOVACAT 301 ALPHA MOTION MASTER	3.04 m	Cat. 2 / Width 2	1000 rpm	3.00
NOVACAT 301 ALPHA MOTION PRO	3.04 m	Cat. 2 / Width 2	1000 rpm	3.00
NOVACAT 301 ALPHA MOTION PRO ED	3.04 m	Cat. 2 / Width 2	1000 rpm	3.00
NOVACAT 301 ALPHA MOTION PRO RCB	3.04 m	Cat. 2 / Width 2	1000 rpm	3.00
NOVACAT 351 ALPHA MOTION MASTER	3.46 m	Cat. 2 / Width 2	1000 rpm	3.40
NOVACAT 351 ALPHA MOTION PRO	3.46 m	Cat. 2 / Width 2	1000 rpm	3.40
NOVACAT 351 ALPHA MOTION PRO ED	3.46 m	Cat. 2 / Width 2	1000 rpm	3.40
NOVACAT 351 ALPHA MOTION PRO RCB	3.46 m	Cat. 2 / Width 2	1000 rpm	3.40

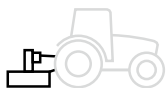

NOVACAT rear mowers with centre pivot mounting	Working width	Mounting	Tractor PTO speed	Hectares per hour up to acres/h / ha/h
NOVACAT 262	2.62 m	Cat. 2 / Width 2	1000 rpm	2.60
NOVACAT 262 ED	2.62 m	Cat. 2 / Width 2	1000 rpm	2.60
NOVACAT 262 RCB	2.62 m	Cat. 2 / Width 2	1000 rpm	2.60
NOVACAT 302	3.04 m	Cat. 2 / Width 2	1000 rpm	3.00
NOVACAT 302 CF	3.04 m	Cat. 3 / Width 3	1000 rpm	3.00
NOVACAT 302 ED	3.04 m	Cat. 3 / Width 3	1000 rpm	3.00
NOVACAT 302 RCB	3.04 m	Cat. 3 / Width 3	1000 rpm	3.00
NOVACAT 352 V	3.46 m	Cat. 3 / Width 3	1000 rpm	3.40
NOVACAT 352	3.46 m	Cat. 3 / Width 3	1000 rpm	3.40
NOVACAT 352 CF	3.46 m	Cat. 3 / Width 3	1000 rpm	3.40
NOVACAT 352 ED	3.46 m	Cat. 3 / Width 3	1000 rpm	3.40
NOVACAT 352 RCB	3.46 m	Cat. 3 / Width 3	1000 rpm	3.40
NOVACAT 402	3.88 m	Cat. 3 / Width 3	1000 rpm	4.00
NOVACAT 442	4.30 m	Cat. 3 / Width 3	1000 rpm	4.50

NOVACAT front and rear mowers

Mower discs	Placement width without swathing discs	Placement width 2 / 4 swathing discs	Transport width	Weight
6	1.70 m	1.30 m / 1.10 m	2.57 m	685 kg
7	2.10 m	1.40 m / 1.10 m	2.98 m	745 kg
8	2.60 m	2.00 m / 1.60 m	3.42 m	805 kg
6	1.70 m	1.30 m / 1.10 m	2.57 m	845 kg
6	1.70 m	1.30 m / 1.10 m	2.57 m	810 kg
6	–	–	2.57 m	1020 kg
6	–	–	2.57 m	1040 kg
7	2.10 m	1.40 m / 1.10 m	2.98 m	885 kg
7	2.10 m	1.40 m / 1.10 m	2.98 m	890 kg
7	–	–	2.98 m	1130 kg
7	–	–	2.98 m	1200 kg
8	2.60 m	2.00 m / 1.60 m	3.42 m	965 kg
8	2.60 m	2.00 m / 1.60 m	3.42 m	1010 kg
8	–	–	3.42 m	1240 kg
8	–	–	3.42 m	1310 kg

Mower discs	Placement width without swathing discs	Placement width 2 / 4 swathing discs	Transport height / length	Weight
6	1.70 m	1.40 m / 1.10 m	3.60 m / –	910 kg
6	–	–	3.60 m / –	1160 kg
6	–	–	3.60 m / –	1230 kg
7	2.10 m	1.70 m / 1.30 m	3.80 m / –	930 kg
7	–	–	– / 4.70 m	1400 kg
7	–	–	3.80 m / –	1260 kg
7	–	–	3.80 m / –	1330 kg
8	2.50 m	2.10 m / 1.70 m	3.99 m / –	1030 kg
8	2.50 m	2.10 m / 1.70 m	– / 5.20 m	980 kg
8	–	–	– / 5.20 m	1460 kg
8	–	–	– / 5.20 m	1340 kg
8	–	–	– / 5.20 m	1390 kg
9	3.20 m	2.70 m / 2.30 m	– / 5.62 m	1040 kg
10	3.60 m	3.00 m / 2.60 m	– / 6.04 m	1080 kg

Technical data

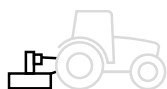

NOVADISC rear mowers with side pivot mounting

	Working width	Mounting	Tractor PTO speed	Hectares per hour up to acres/h / ha/h
NOVADISC 222	2.20 m	Cat. 2 / Width 2	540 rpm	2.20
NOVADISC 262	2.62 m	Cat. 2 / Width 2	540 rpm	2.60
NOVADISC 302	3.04 m	Cat. 2 / Width 2	540 rpm	3.00
NOVADISC 352	3.46 m	Cat. 2 / Width 2	1000 rpm	3.40

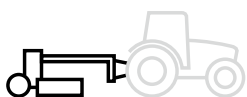

NOVACAT T trailed mowers

	Working width	Mounting	Tractor PTO speed	Hectares per hour up to acres/h / ha/h
NOVACAT 307 T ED	3.04 m	Cat. 2 / Width 2	1000 rpm	3.60
NOVACAT 307 T RCB	3.04 m	Cat. 2 / Width 2	1000 rpm	3.60
NOVACAT 307 T ED COLLECTOR	3.04 m	Cat. 2 / Width 2	1000 rpm	3.60
NOVACAT 307 T RCB COLLECTOR	3.04 m	Cat. 2 / Width 2	1000 rpm	3.60
NOVACAT 3007 T ED	3.04 m	Cat. 2 / Width 2	1000 rpm	3.60
NOVACAT 3007 T RCB	3.04 m	Cat. 2 / Width 2	1000 rpm	3.60
NOVACAT 3007 T RCB COLLECTOR	3.04 m	Cat. 2 / Width 2	1000 rpm	3.60
NOVACAT 3507 T ED	3.46 m	Cat. 2 / Width 2	1000 rpm	4.20
NOVACAT 3507 T RCB	3.46 m	Cat. 2 / Width 2	1000 rpm	4.20
NOVACAT 3507 T ED COLLECTOR	3.46 m	Cat. 2 / Width 2	1000 rpm	4.20
NOVACAT 3507 T RCB COLLECTOR	3.46 m	Cat. 2 / Width 2	1000 rpm	4.20

NOVADISC rear mowers / NOVACAT T trailed mowers

Mower discs	Placement width without swathing discs	Placement width 2 / 4 swathing discs	Transport height	Weight
5	1.30 m	0.90 m / -	2.57 m	635 kg
6	1.70 m	1.50 m / 1.10 m	2.96 m	675 kg
7	2.30 m	1.70 m / 1.30 m	3.34 m	715 kg
8	2.50 m	2.10 m / 1.70 m	3.78 m	760 kg

Mower discs	Placement width	Placement width 2 / 4 swathing discs	Transport width / height / length	Weight
7	1.90 m / 2.70 m	-	3 m / 2.80 m / 6.1 m	1991 kg
7	1.70 m / 2.50 m	-	3 m / 2.80 m / 6.1 m	2051 kg
7	-	-	3 m / 2.80 m / 7.2 m	2530 kg
7	-	-	3 m / 2.80 m / 7.2 m	2545 kg
7	1.90 m / 2.70 m	-	3 m / 2.80 m / 7.56 m	2131 kg
7	1.70 m / 2.50 m	-	3 m / 2.80 m / 7.56 m	2190 kg
7	-	-	3 m / 2.80 m / 8.6 m	2710 kg
8	2.20 m / 3.10 m	-	3.42 m / 2.08 m / 7.56 m	2206 kg
8	2.20 m / 3.00 m	-	3.42 m / 2.08 m / 7.56 m	2286 kg
8	-	-	3.42 m / 2.08 m / 8.6 m	2825 kg
8	-	-	3.42 m / 2.08 m / 8.6 m	2890 kg



Scan the QR Code on the data plate of a PÖTTINGER machine or enter the machine number at www.poettinger.at/poetpro.

Choose the information you need.

PÖTPRO – Simple. Anytime. Anywhere.

For all PÖTTINGER machines 1997 models onwards

PÖTPRO stands for PÖTtinger PROduct information for Pöttinger Professionals. We have created PÖTPRO as a tool to provide machine specific information for all machines from year of build 1997 onwards.

Simply scan the QR code on the data plate with your smartphone or tablet or enter your machine number at www.poettinger.at/poetpro.

Your machine goes online.

All the information on your machine.

You will immediately receive all the information on your machine.

- Instruction manual
- Optional equipment information
- Brochures
- Photos and videos.

ORIGINAL PARTS



CLASSIC

DURASTAR

DURASTAR PLUS

Rely on the original

PÖTTINGER Original Parts meet the highest demands in terms of functionality, reliability and performance. These are characteristics that PÖTTINGER is committed to delivering.

That is why we manufacture PÖTTINGER Original Parts from the highest quality materials. We ideally match each individual spare part and wear part to your machinery's overall system. This is because different soil and operating conditions often need to be taken into consideration.

We have been listening to our customers and now offer three different lines - CLASSIC, DURASTAR and DURASTAR PLUS - to make sure you have the right part to meet every requirement. Original parts are worth every cent, because know-how cannot be copied.

Your advantages

- Immediate and long-term availability.
- Maximum durability thanks to innovative production processes and the use of the highest quality materials.
- Avoidance of malfunctions due to a perfect fit.
- The best working results thanks to optimum match to the overall system of the machine.
- Save time and costs thanks to longer replacement intervals on wear parts.
- Comprehensive quality testing.
- Ongoing advancement through research and development.
- Worldwide spare parts supply.
- Attractive, competitive prices for all spare parts.

Wear parts

The CLASSIC line is for standard duty applications. With these ORIGINAL INSIDE parts we have defined the benchmark for quality, best price/performance ratio and reliability.

DURASTAR is the innovation on the wear components market - durable, high quality, productive and reliable.

Are you used to putting your machines to work in the most extreme conditions? Then the DURASTAR PLUS line is the right choice for you.



More Success with PÖTTINGER

- A family-owned company since 1871.
Your reliable partner.
- Specialist for tillage, seed drills.
Hay and harvesting machines.
- Future-safe innovation for outstanding working results.
- Roots in Austria - at home throughout the world.

You can rely on our PÖTTINGER disc mowers

- The best forage thanks to optimum ground tracking.
- First-class cutting thanks to proven PÖTTINGER cutter bars.
- High quality design of strong and reliable mowers.
- Straightforward and convenient operation.

Ask our sales partners for more information:

PÖTTINGER Landtechnik GmbH

Industriegelände 1
4710 Grieskirchen
Austria
Phone +43 7248 600-0
info@poettinger.at
www.poettinger.at

Alois PÖTTINGER UK Ltd.

15 St Marks Road, Corby
Northamptonshire,
NN18 8AN
United Kingdom
Phone + 44 1536 272 220
info@pottingeruk.co.uk
www.pottingeruk.co.uk

POETTINGER Canada Inc.

460 Rue Robinson Sud
Granby, QC, J2G 7N6
Canada
Phone +1 450 372 5595
Fax +1 866 417 1683
info@poettinger.ca
www.poettinger.ca

POETTINGER US, Inc.

393 Pilot Drive
Valparaiso, IN 46383
USA
Phone +1 219 510 5534
Fax + 1 219 707 5412
info@poettinger.us
www.poettinger.us

PÖTTINGER Australia PTY LTD

11 Efficient Drive
Truganina VIC 3029
Australia
Phone +61 3 8353 2770
info@poettinger.com.au
www.poettinger.com.au

POETTINGER Ireland Ltd.

Glenaleamy, Powerstown Road,
Clonmel, Co. Tipperary
Ireland
Phone +353 52 6125766
info@poettinger.ie
www.poettinger.ie

Importer for New Zealand:

Origin Agroup
PO Box 673, 57 Hautapu Road
Cambridge
New Zealand
Phone +64 7 823 7582
info@originagroup.co.nz
www.originagroup.co.nz

Importer for South Africa:

VALTRAC
Cnr. Water & Buiten Street
9585 Parys
South Africa
Phone +27 56 817 7338 7308
wynn@valtrac.co.za
www.valtrac.co.za